



Final Report: Irrigators – the flow-on benefits of regionally embedded generation

PREPARED FOR:
Energy Consumers Australia



About the authors

The Institute for Sustainable Futures (ISF) is an interdisciplinary research and consulting organisation at the University of Technology Sydney. ISF has been setting global benchmarks since 1997 in helping governments, organisations, businesses and communities achieve change towards sustainable futures.

We utilise a unique combination of skills and perspectives to offer long term sustainable solutions that protect and enhance the environment, human wellbeing and social equity.

For further information visit: www.isf.uts.edu.au

Research team

Chris Briggs

Research Principal

Institute for Sustainable Futures

Kriti Nagrath

Senior Research Consultant

Institute for Sustainable Futures

Franziska Mey

Senior Research Consultant

Institute for Sustainable Futures

Joseph Wyndham

Research Consultant

Institute for Sustainable Futures

Citation

Please cite as: Briggs, C., Nagrath, K., Mey, F., Wyndham, J., (2018) Irrigators - the flow on benefits of regionally embedded generation, Final Report, prepared for Energy Consumers Australia, Institute for Sustainable Futures, UTS.

Acknowledgements

We would like to thank Energy Consumers Australia for commissioning this research; our partners, particularly Stefanie Schulte, NSW Irrigator's Council, Georgina Davis, Queensland Farmers' Federation and Jennifer Brown, Cotton Australia for their guidance and support in the project; and the growers, consultants and representatives of the DNSPs who participated in the interviews and the feedback workshop. Chris Dunstan and Ed Langham (ISF) also provided valuable input.



Institute for Sustainable Futures

University of Technology Sydney
PO Box 123 Broadway, NSW, 2007
www.isf.edu.au

Disclaimer

This project was funded by Energy Consumers Australia Limited (www.energyconsumersaustralia.com.au) as part of its grant process for consumer advocacy projects and research projects for the benefit of consumers of electricity and natural gas. The views expressed in this document do not necessarily reflect the views of the Energy Consumers Australia.

The authors have used all due care and skill to ensure the material is accurate as at the date of this report, however, UTS and the authors do not accept any responsibility for any losses that may arise by anyone relying upon its contents. In particular, tariff rates and regimes may vary significantly from those used in this work and have a significant effect on the results.

© UTS January 2019

Contents

Glossary	4
Key Terms Summary	5
Executive Summary	6
1 Introduction	18
1.1 Context	18
1.2 About the project	18
1.3 About the report	19
1.4 Research approach	19
2 Connecting Renewable Energy to the Grid: Benefits and Opportunities	21
2.1 On-farm renewable energy: benefits for growers	21
2.2 On-farm renewable energy: opportunities for partnerships between growers & DNSPs	25
2.3 Conclusion	28
3 Connecting Renewable Energy to the Grid: Regulatory and Policy Context	29
3.1 Connection regulations: National Electricity Rules	29
3.2 Chapter 5A: reviews	32
3.3 Towards Harmonisation: Energy Networks Australia Connection Guides	34
3.4 Voluntary Codes: Networks, Retailers and Installers	35
3.5 Conclusion	35
4 Connecting Renewable Energy in the Irrigation Sector: Key Challenges	36
4.1 Grid connection for renewable energy: barriers for growers	37
4.2 Grid connection of renewable energy: DNSP challenges & strategies	44
5 Recommendations	50
5.1 Key themes	50
5.2 Recommendations	52
6 References	63

Glossary

Abbreviation	Term
ACCC	Australian Competition and Consumer Commission
AEMC	Australian Energy Market Commission
AEMO	Australian Energy Market Operator
AER	Australian Energy Regulator
ANZ	Australia and New Zealand Banking Group
CBA	Commonwealth Bank of Australia
CEC	Clean Energy Council
CEFC	Clean Energy Finance Corporation
CSIRO	Commonwealth Scientific and Industrial Research Organisation
DMIA	Demand Management Innovation Allowance
DMIS	Demand Management Incentive Scheme
DNSP	Distribution Network Service Provider
DRE	Distributed Renewable Energy
DER	Distributed Energy Resource
ENA	Energy Networks Australia
FIT	Feed in Tariff
LCC	Lifecycle Cost
NAB	National Australian Bank
NOM	Network Opportunity Map
NSW	New South Wales
NSWIC	NSW Irrigators' Council
PPA	Power Purchase Agreement
QFF	Queensland Farmers' Federation
Qld	Queensland
RE	Renewable Energy

Key Terms Summary

Term	Description
Network Constraint	Where the network is constrained, customers can't connect or export electricity to the network when and where they would like. Network constraints can be due to hosting capacity issues or reliability issues. Constraints are the product of the technical limits of the network: broadly thermal limits (the volume of power), voltage regulation, and fault-levels.
Hosting Capacity	Hosting Capacity refers to the capacity of the distribution system to absorb distributed energy flows. The hosting capacity of a feeder in the distribution circuit is defined by the limiting elements and electrical limits of the circuit. For example, it's a way of quantifying how much solar the utility can allow on a feeder before upgrades are needed.
Reliability	Reliability of electricity systems is a measure of the ability of the electricity system to meet customer demand — that is, having capacity available in the right place and at the right time. One of the key indicators is the average number of unplanned outages per year – in terms of duration and frequency.
Non-Network Solutions	Non-network solutions are alternatives to network augmentation to address a potential shortfall in electricity supply in a region. They can be used to defer or avoid capital expenditure associated with network investment and deliver benefits to consumers through lower transmission prices. Non-network solutions may include distributed energy resources and demand management initiatives that can provide additional local power generation and lower peak demand during peak demand periods.
Demand Management Incentive Scheme (DMIS)	AER launched the DMIS in 2017. The Scheme's objective is to provide electricity distribution businesses with an incentive to undertake efficient expenditure on demand management alternatives to network investment. Consumers can choose whether to engage in demand management schemes.
Demand Management Innovation Allowance (DMIA) Mechanism	AER launched the DMIA in 2017. The DMIA's objective is to provide distribution businesses with funding for research and development in demand management projects that are not currently cost-effective but have the potential to reduce long term network costs.

Executive Summary

Rising electricity prices are having a major impact on the competitiveness of irrigated agriculture in NSW and Queensland. The cost of electricity ranges from ten per cent to almost one-third of production costs. Electricity bills for irrigators increased by up to 300 per cent between 2009 and 2014 and have continued to rise subsequently. In the context of rising energy prices, growers have investigated a range of options to reduce energy costs, including more energy efficient equipment and on-farm renewable energy.

However, growers have encountered a range of operational and financial barriers to on-farm renewable energy – including grid connection processes and export limitations. For many forms of irrigated agriculture, grid connection has a critical impact on the cost effectiveness of renewable energy because their energy usage is highly variable. Consequently, unless growers can export electricity back to the grid when it is not being used on farm, the financial returns from a solar system are significantly reduced. From the perspective of Distribution Network Service Providers (DNSPs), integrating renewable energy presents technical challenges. Variable renewable energy can impact on thermal and voltage limits that need to be maintained for network security and reliability. Further, there is often low visibility on conditions within low-voltage areas of the network when assessing connection applications.

Energy Consumers Australia have provided funding to NSW Irrigators' Council, Cotton Australia and the Queensland Farmers' Federation for a comprehensive review of the issues growers face when seeking to connect RE to the distribution network, and to find ways of better aligning Distribution Network Service Providers (DNSP) and grower interests.

The objectives of this study are to:

- Identify and record the challenges and obstacles experienced by growers who have installed renewable energy generation on farm including those who have tried to feed excess energy generated back into the grid.
- Analyse network connection applications with regard to technical, operational and process barriers that limit growers from feeding on-farm generated energy back into the grid.
- Review the implications of, and effectiveness to date of Chapter 5A amendments to the National Electricity Rules to assist embedded generators under 5MW to connect to the electricity distribution network.
- Identify and communicate possible future opportunities with the DNSPs for renewable energy projects throughout rural Queensland and NSW, with a view to better aligning growers and DNSP interests.

The study adopted a bottom-up, evidence-based approach using a multi-method research design (case studies, semi-structured interviews, focus groups, online survey, and literature review). The focus was on engaging with growers and DNSPs to understand their perspectives, challenges and develop viable opportunities for them to work together.

The research methodology included four case studies across Queensland and NSW (encompassing a range of crop types and network contexts), an online grower survey and telephone interviews with the DNSPs. A workshop was conducted to report and test the findings and recommendations with the NSW Irrigators' Council, Cotton Australia, Queensland Farmers Federation and DNSPs in NSW and Queensland. This

report synthesises the findings from the research to present key recommendations for different stakeholders.

Grid-connection of on-farm renewable energy: the current process

The first finding of our research is there is very little direct contact between the DNSPs and growers; grid connections are managed by a range of third-parties for growers (either the solar supplier, an installer or consultant). The third-party that mediates the relationship between the growers and DNSPs is usually selected when growers are purchasing the system.

The issues and barriers identified by growers stretch from pre-sale before the involvement of networks and extend throughout the network connection process. A strong theme that emerged was the confusion and mistrust growers felt towards RE suppliers. There is a lack of independent information or support for growers to select the right system and suitably qualified RE supplier - who will also generally manage the grid connection process. Our research found no awareness or use among growers of the Solar Retailer Code of Conduct which is designed to promote best practice for suppliers.

Consequently, solutions need to encompass solar suppliers as well as the DNSP-grower relationship.

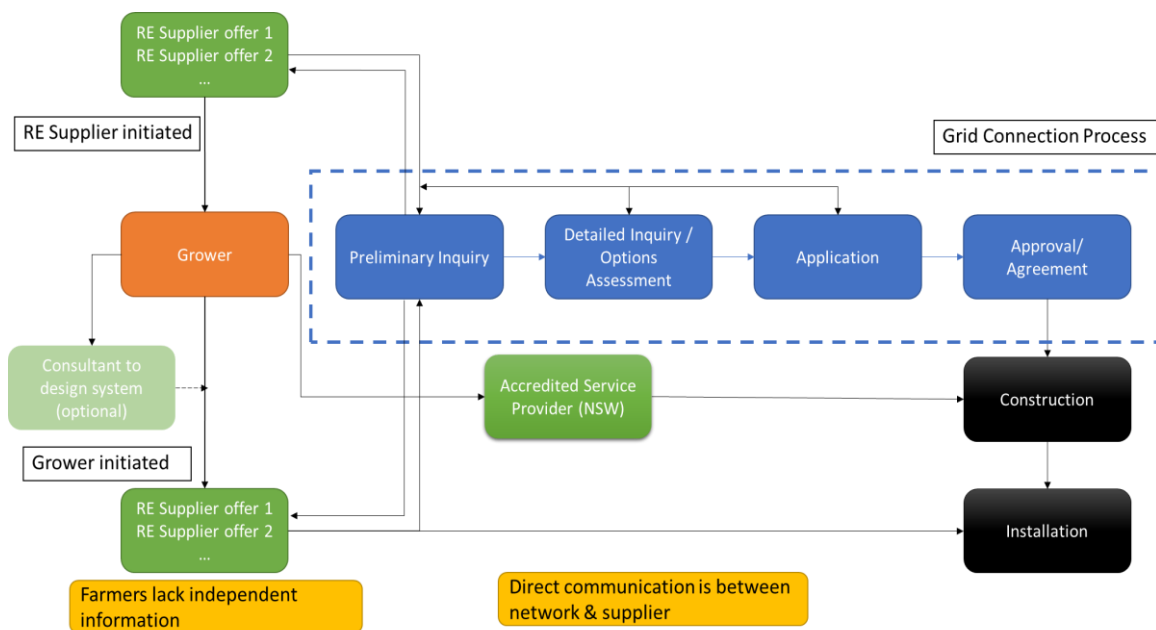

Figure 1: Installing and Connecting On-Farm Renewable Energy

The research found that the supplier-initiated approach to installing solar photovoltaic (PV) systems was most common (often through cold-calling). In some instances, particularly where the process is grower-initiated, consultants are engaged to assist in the design and integration of the renewable energy system with the existing farm equipment.

There are variations between the approaches of the DNSPs in managing assessment of renewable energy connections, but the building blocks of the process (i.e. the steps

for the preliminary and detailed inquiry and the application) are similar in both jurisdictions. One major difference which emerged is that in NSW connection works are undertaken by accredited service providers under a contestable works scheme whereas it is managed by the DNSP in Queensland. The NSW model offers greater competition but also adds another party to the connection process that mediates the relationship between DNSPs and growers.

It is important to note no process for network-initiated projects for distributed energy resources (DERs) could be identified at this stage. The Regulatory Investment Test for DNSPs could provide a vehicle for expenditure but it has not been used for DERs yet.

The emergence of distributed energy technologies creates opportunities for DNSPs to initiate projects with growers that can reduce capital, operating and replacement expenditure. For example, smart inverters paired with solar could assist in voltage management, and solar paired with storage and load management could avoid new investment to meet demand peaks or extend the lifetime of aging assets. It is generally accepted that DERs will likely deliver network benefits in the future, but the pathway to that future is not yet clear. DNSPs are still experimenting with and assessing DER-based network solutions and there are barriers that need to be addressed. For example, there is often insufficient visibility of conditions in the low-voltage network and the infrastructure for communicating and controlling devices on consumer premises is generally not in place.

Grid connection of on-farm renewable energy: key barriers

A series of reviews have investigated grid connection processes and highlighted a range of issues for users trying to connect renewable energy systems to the distribution network (ClimateWorks Australia, Property Council of Australia and Seed Advisory, 2015; Energeia, 2016; ClimateWorks Australia and Seed Advisory, 2017; Climateworks Australia and Seed Advisory, 2018; ENA, 2018). The NSW Government also commissioned a review of NSW transmission and DNSPs (CutlerMerz, 2018).

There is broad agreement across major reviews of grid connection processes under the Chapter 5A process introduced in 2014 that there are negative impacts on renewable energy projects including:

- Higher costs (time and connection costs);
- Barriers to entry and the adoption of new decentralised energy technologies from network requirements (including storage, demand management equipment, charging infrastructure);
- Investment uncertainty: projects are sometimes abandoned or do not proceed due to policy and regulatory uncertainty, delays or rulings by DNSPs that the network either cannot accommodate more renewable energy or with significant conditions that would impact on the viability of the project;
- Under-sizing of renewable energy installations: projects are sized within the load profile of the site to avoid export.

There is also recognition that inefficiencies with the existing arrangements have created problems for network businesses trying to process the rapidly growing volume of connections (e.g. issues with the quality of applications).

The experience of growers in our research aligns with the conclusions of these reviews. Broadly, growers identified a range of technical, economic, information and contractual barriers to installing renewable energy generation and feeding excess energy back into the grid (Figure 2).

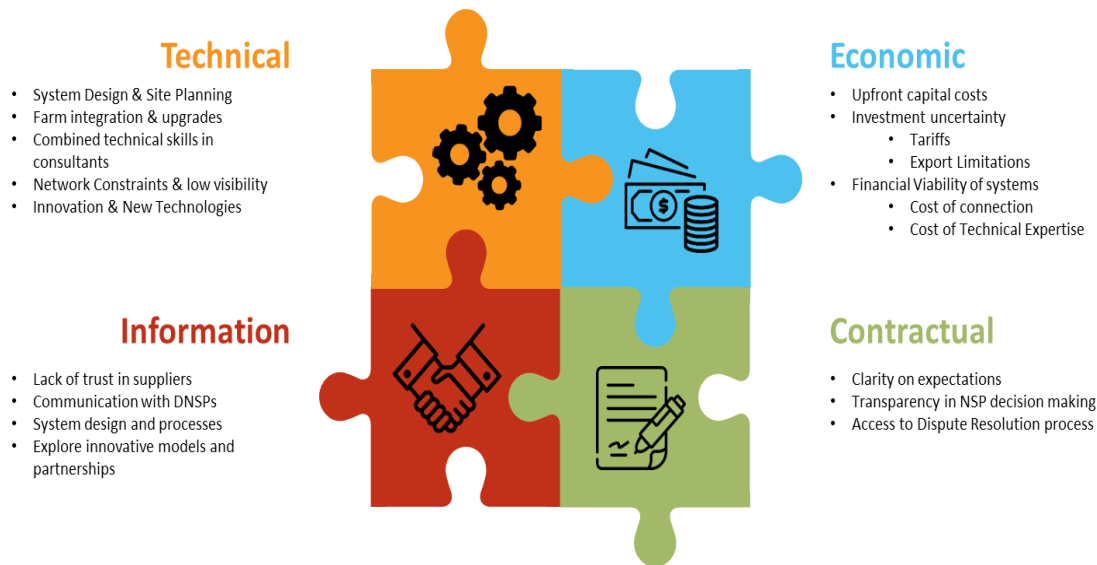

Figure 2: Barriers to Installing and Connecting On-Farm Renewable Energy

Growers, irrespective of the path they chose to connect to the grid, found the connection process complex and uncertain. Communication processes are not working well between DNSPs and growers. There were high levels of confusion and conflicting accounts of the process from growers and DNSPs. Growers reported cases of rejected applications, applications where export limitations were rescaled several times without explanation or the provision of alternatives. In some other instances, applications were only approved after lengthy assessment and subject to costly upgrades. However, DNSPs reported that they do not reject connections and always provide guidance on the measures required (noting this could require costly upgrades on occasions). With the relationship currently mediated by third-parties, the transfer of information from DNSPs to growers via third-parties is not currently leading to effective communication and understanding. The complexity, policy and regulatory uncertainty, time, and cost of the grid connection process is leading some growers not to proceed with planned RE systems (i.e. solar). Many of the issues identified by the growers were common to both jurisdictions.

Recommendations

As the issues and barriers extend across the procurement process, the following recommendations extend beyond the DNSPs to encompass the clean energy industry, state governments, grower industry associations and cooperatives, and Energy Consumers Australia.

Recommendation 1: Establish Regional Energy Hubs to support growers and facilitate partnerships with DNSPs and other stakeholders

Our study has highlighted a need to change the process by which growers are currently procuring and connecting renewable energy. Our key recommendation is for the establishment of independent intermediaries (or Regional Energy Hubs) that can provide independent information and advice to growers and facilitate interactions and partnerships between growers, installers and network service providers (Coalition for Community Energy, 2016). The effectiveness of an intermediary organisation has been proven nationally and internationally.

Regional Energy Hubs could:

- Provide independent information on technologies, consumer rights, solar suppliers, grid connection processes, and network capacity (through the Network Opportunity Maps, NOM).
- Coordinate outreach education programs.
- Develop partnerships with councils, funders, technology providers, and networks to deliver innovative RE projects (such as bulk-buy initiatives and demonstration projects).

Figure 3 illustrates how a 'Growers Energy Hub' could work.

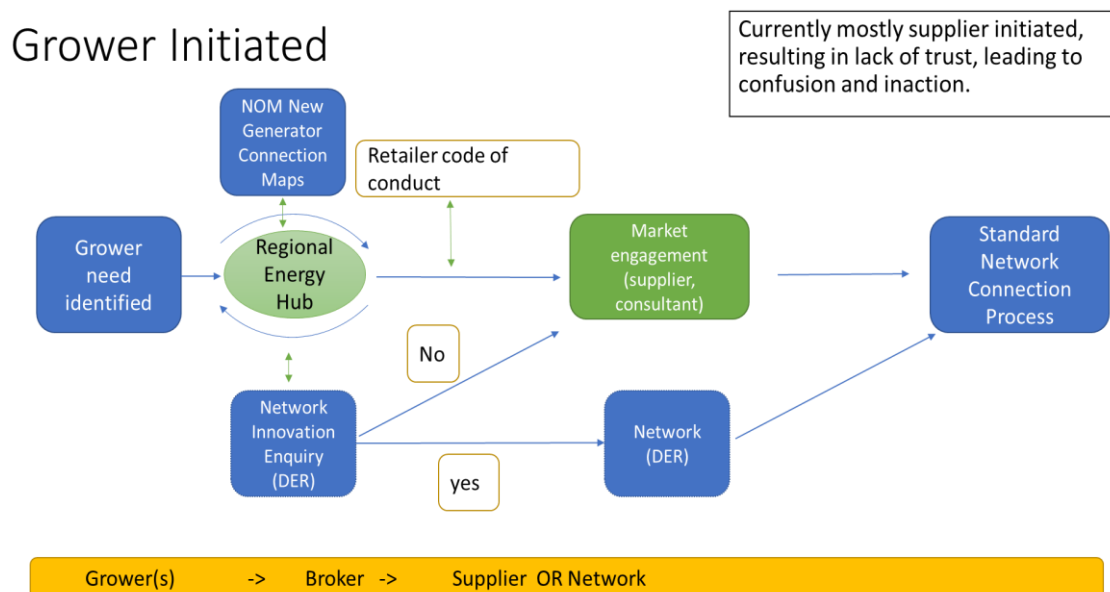

Figure 3: Grower-Initiated Projects with a Regional Energy Hub

The Regional Energy Hub could also:

- Improve the operation and uptake of the Solar Retailer Code of Conduct by increasing awareness and implementation.
- Support DNSPs improve their efficiency with connection applications (filtering the rapidly growing number of connection applications).
- Facilitate the growth of network-initiated projects that deliver win-win outcomes. As networks develop processes to identify DER projects, the Hubs could recruit growers into these projects by referral to the network business.

The process is explained in more detail in Section 5.

Recommendation 2: Changes to National Electricity Rules, Chapter 5A (Electricity connection for retail customers) should be considered if voluntary model grid connection processes fail to meet performance benchmarks

Energy Networks Australia, the Clean Energy Council (CEC), energy regulatory bodies, and Energy Consumers Australia are developing voluntary model connection processes (micro, low, medium and high-voltage) that will be implemented by each of the DNSPs.

Many of the issues identified in this study and other reviews of Chapter 5A of the National Electricity Rules can be addressed by the DNSPs without rule changes through voluntary codes. These issues include creating a common communications platform, standardised and streamlined technical requirements, better information provision for applicants and industry.

However, it has also been noted by several reviews that the network connection process is currently lightly regulated without oversight as to whether network rules strike the appropriate balance between consumer interests and grid stability.

If the voluntary model process does not deliver results, regulatory approaches should be implemented including creating a clear process for oversight of network connection process rule-setting. The Australian Energy Regulator should establish clear and specific performance benchmarks for evaluating the voluntary codes based on issues and criteria identified in past reviews and the energy rule determination in 2014:

- Provision of transparent information requirements;
- Fair and reasonable connection costs;
- Connection process times;
- Entry to market for new technologies;
- Service standards.

Independent evaluation of the voluntary codes is scheduled to occur within 2-years but it is unclear whether that evaluation will include consultation with actual customers such as growers. Our research has highlighted the lack of communication between the end-users and DNSPs. It is important that the customers for the connection process (i.e. end-users and the specialists who manage connections for them) are involved as part of the evaluation process.

Recommendation 3: DNSPs and Grower Cooperatives/Industry Associations should investigate opportunities for demonstration projects through the Demand Management Incentive Scheme and Demand Management Innovation Allowance

One of the main barriers to grid integration of RE are the technical standards that are maintained by the DNSPs to maintain security and reliability. Equally, DNSPs need to develop processes that can enable them to take advantage of the opportunities presented by DER.

Pilot projects are highlighting real solutions that could unlock the capacity for growers to install higher volumes of RE. For example:

- *Networks Renewed*: Stage 1 of an ARENA-funded project with DNSPs has successfully demonstrated that smart inverters can be used with solar PV to manage voltage issues. A larger-scale demonstration project could test their use across different sectors and network contexts.
- *REALM (Renewable Energy and Load Management)*: Stage 1 of an ARENA-funded project with seven major businesses has identified the scope to use existing on-site storage and load flexibility, increasing the value of RE and better matching supply and demand (generally at a lower cost than new batteries). REALM Stage 2 is currently being developed to implement two pilots involving DNSPs and retailers. This will test different types of load flexibility opportunities with tariffs that align prices with the value that can be created for DNSPs and energy markets. Irrigation projects would also offer excellent opportunities to apply REALM, especially for crops where there is flexibility in timing of pumping, on-site refrigeration, cooling and heating, or material storage.

- *Microgrids*: There are several microgrid trials across the country highlighting how RE can benefit both the DNSP and consumers. Used smartly, these approaches can help in mitigating expensive network augmentation and replacement costs and enhance reliability. Both Energy Queensland and Essential Energy are considering options for microgrid projects.
- *Local Electricity Trading*: There are a few trials on peer-to-peer energy trading in Australia. For example, LO3 and ARENA are using Blockchain technology to allow households and businesses to trade or share locally generated power with each other in Latrobe Valley, Victoria. Power Ledger is also working with Origin to explore the benefits of this mechanism.

Funding for these types of projects is potentially available through the Demand Management Incentive Scheme and Demand Management Innovation Allowance, the Regulatory Investment Test – Distribution (RIT-D) and ARENA. Grower associations and cooperatives should investigate opportunities for the deployment of projects in partnership with the DNSPs, and potentially with ARENA and state governments.

Once the DNSP has identified potential areas, regional energy hubs (Recommendation 1) could play an on-going role brokering partnerships for network-initiated projects and supporting networks to develop a new, pro-active role in harnessing distributed energy. A process for how network-initiated projects with the involvement of Regional Energy Hubs might work is presented in Figure 4.

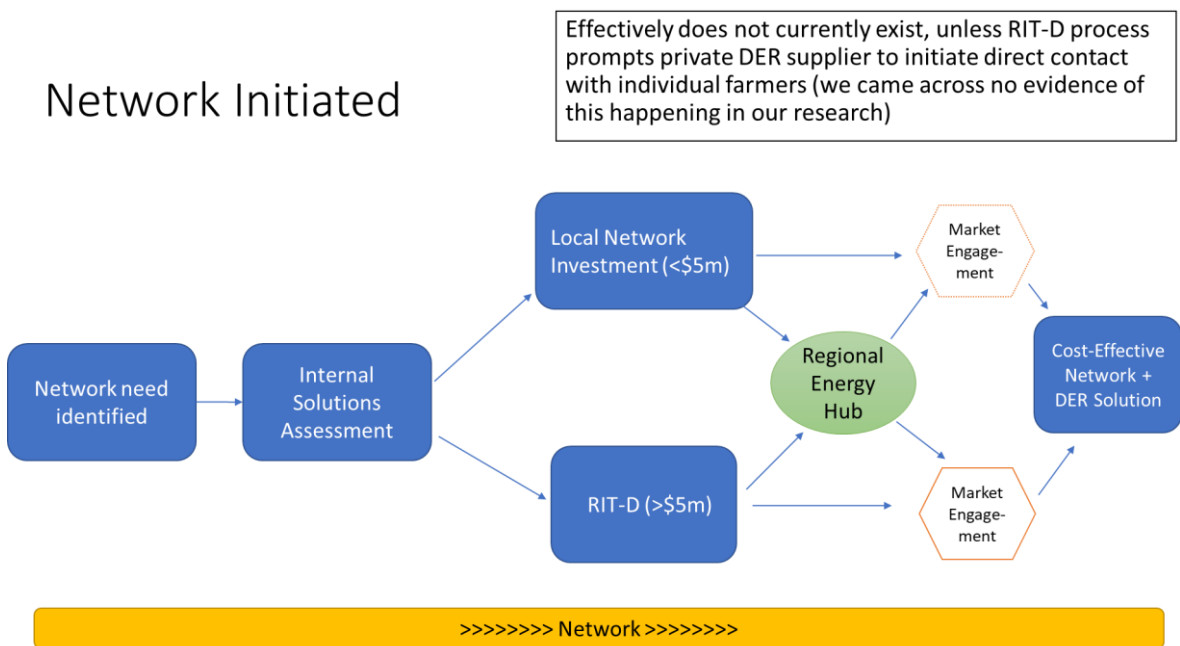

Figure 4: Network Initiated Distributed Energy Projects

Recommendation 4: The AER should provide clear guidance to DNSPs on network expenditure on low-voltage network data and procedures to facilitate cost effective distributed energy and demand management.

Higher levels of DRE can reduce the energy bills of growers but also, if managed well, potentially deliver system-wide reductions in the cost of generation and networks. Investment is required to address the two major technical barriers to integrating higher penetrations of RE:

- Improved information and data on network conditions in low-voltage feeders: networks will continue to apply conservative export limits without better information to determine the actual times and locations when constraints occur.
- Network augmentation (e.g. voltage regulators) and/or non-network solutions (e.g. smart inverters with on-site PV) to maintain technical standards (e.g. voltage regulation and thermal limits) whilst integrated DER.

In theory, the RIT-D framework might support network investment to improve visibility of low-voltage network conditions and network and/or non-network solutions to facilitate higher penetrations of DRE but in practice there is uncertainty over eligibility and requirements for funding.

In the interviews we conducted with DNSPs, staff considered there was no scope for network augmentation where there were technical impacts. In such cases, proponents were responsible for making capital contributions which could be recouped from subsequent connections. Placing the onus on individual proponents is neither equitable nor likely to lead to an efficient level of investment. The Cutler Merz review (2018: 27) of NSW distribution networks noted similarly:

The ability of distribution networks to invest in infrastructure to facilitate alternative energy system connections is even less clear. In many distribution networks across the NEM, the penetration of distributed generation is reaching levels sufficient to create unacceptable voltage rise and power quality impacts requiring investment in network reinforcement to first address existing issues and then to allow for increased penetration.

The Australian Energy Market Commission has looked at the question of whether networks can invest in improved low voltage network data, modelling and monitoring. In its 2017 *Distribution Market Model Review* (p.45), they concluded it was ‘unclear’ - although in the 2018 *Economy Regulatory Framework Review* the AEMC assessed that the existing framework could support efficient investments to improve understanding of low-voltage networks.

However, as the AEMC further notes, there have been no RIT-D applications for these types of investment and there would be benefit in the AER providing guidance and worked examples to provide clarity (as it is required to do under the National Electricity Rules); ‘To date, there have not been any RIT-Ds that have considered this type of investment so there are limited precedents for distribution NSPs to understand how they would be assessed under the RIT-D ... The Commission considers that establishing methodologies for valuing DER across a range of situations in which DER provides value to the network and wider market would have a number of benefits.’¹

Our research supports this conclusion as it is not clear there is an understanding of how or under what circumstances networks can invest in better low-voltage network

¹ Further, the AEMC (2018: 102-03) noted: ‘To date, there have not been any RIT-Ds that have considered this type of investment so there are limited precedents for DNSPs to understand how they would be assessed under the RIT-D. As part of a RIT-D process, the DNSP will also need to consider the methodology for valuing the market benefits of DER. We consider that there would be benefit in the AER providing increased guidance on the methodologies for valuing market benefits and including worked examples for DNSPs as part of its review of the application guidelines. Worked examples demonstrating a market benefit would be useful in relation to both to building monitoring capabilities if the AER considers this to be a RIT project and an augmentation of the distribution network to increase the hosting capacity for DER.’

data visibility and augmentations for integrate DER.² Indeed, network augmentation does not even appear to be considered as a possibility. The DMIS should provide an opportunity for the AER to trial and determine rules for the valuation of distributed energy resources and investment by networks.

Recommendation 5: DNSPs should improve the provision of information on locational opportunities and constraints for the connection of renewable energy

Greater provision of information on system stability and reliability could allow identification of other value streams not yet monetised and guide connection applications (saving both networks and growers time and resources). Growers have limited insight into the capacity of the local network to accommodate RE and opportunities to reduce network costs.

There are a number of ways in which information could be improved

- *Increase availability of data on system reliability and/or stability* to increase market and end user insight into areas of network need that might represent DER value provision, but not yet be reflected in the DNSP investment plans. This could be done through existing public data platforms such as the Network Opportunity Maps (NOM), or via direct communication with specific parties looking to coordinate opportunities. A regional energy hub could link closely with strategic regional economic planning.
- *Continue to improve disclosure and granularity of new generator network connection capacity* data to direct early stage distributed energy project investigations. For NSW this involves exploring the provision of data below 33kV. For Queensland, a first step is the provision of data for 33kV and above to connect with the information supplied by the transmission network Powerlink.
- *Ensure all potential future network constraint investments and sub-investments are disclosed as part of System Limitation Reports* (then mapped to the NOM), including those with varying degrees of uncertainty. This includes smaller investments in the low-voltage system that might not traditionally be exposed to a regulatory investment test (RIT-D) process.

Recommendation 6: State Governments should engage with the third-parties that manage grid connection processes and work to improve third party communication with growers.

All third-party suppliers need to be registered with State Governments. In NSW, Accredited Service Providers (ASPs) are required to be accredited and registered by the Department of Planning and Environment. In both states, an electrical licence holder is required for installations. In Queensland, it is advised that the installer has a CEC accreditation and a relevant Queensland Building and Construction Commission (QBCC) licence or an unrestricted electrical contractor licence.

State governments should use their position to influence third-parties in relation to service standards and communication with end-users. The State Governments should ensure that the accreditation and registration process include a check-list or guideline for third parties on the service expectations for growers and other consumers. The accreditation process aims to facilitate the market, but compliance and enforcement should be considered in its establishment.

² The AEMC recommended this be done in the current review of the RIT-D guidelines. However, the draft RIT-D guidelines released in July 2018 do not specifically address issues related to distributed energy resources (AER 2018).

All the distribution businesses are currently developing model connection processes through their peak body, Energy Networks Australia, to improve communications and information provision. To be effective, action will also be required to improve the communication through third-parties to growers and guidelines for service providers would assist in this process. However, this is an issue state governments should monitor as part of their accreditation role and use periodic audits to ensure third parties are following guidelines.

Recommendation 7: DNSPs should establish an on-line register with information on past renewable energy connection applications and a FAQ for third-parties to distribute to applicants.

One of the ways in which DNSPs could help growers to understand connection processes is to establish an online register which summarises the results of past connection applications by area. Key information provided would include the size of the application, the result of the application, and reasons where there were alterations or a refusal.

The benefits would include:

- Signalling for the market where there are hosting capacity constraints and in general recent outcomes of connection applications to shape expectations;
- Better understanding for future applicants of the connection process to prevent mistakes, incomplete or unacceptable applications;
- Improved capacity for DNSPs and the market to analyse trends and identify issues that require resolution for future applicants. In addition to informing applicants, aggregation of data will improve visibility of issues for DNSPs.

This could take the form of a relevant page on the website, or as an additional layer on the Network Opportunity Maps that the DNSPs are already provide data for and cooperate on.

A key issue that would need to be addressed are the privacy concerns of previous applicants. The DNSP would need to develop a process to obtain customer consent prior to sharing information publicly or widely.

Alongside the establishment of a register, DNSPs can develop a factsheet or FAQs that explains responses to commonly received problems in accessible language. For DNSPs, the 'customer' is usually the third-party that manages the connection process or works, rather than the end-user but poor communication with growers is harming the DNSPs reputation and sowing confusion. DNSPs could assist in improving communication by developing a FAQ to be distributed by third-parties to growers (and other connection applicants).

State Governments could support the DNSP initiative by bringing together the different DNSPs in their jurisdiction to support its development. State wide programs will help build a broader community of practice and experience sharing.

Transmission networks are required to publish information on new connections under the draft Transmission Annual Report Guidelines (section 4.1.3). Our recommendation is that DNSPs should also be required to publish basic information on past connection applications to assist non-expert applicants, such as growers and the parties that manage their connection applications.

Recommendation 8: The Clean Energy Council and Energy Consumers Australia should undertake outreach engagement to improve the effectiveness of the Solar Retailer Code of Conduct.

The Solar Retailer Code of Conduct (a voluntary code administered by the CEC to promote best practice by the vendors of solar systems) could be a vehicle for improving performance standards. The code is reviewed and authorised by the ACCC and overseen by an independent Code Review Panel – established in accordance to the Code of Conduct with an independent chair. The coverage of the Solar Retailer Code of Conduct is growing strongly; the 2017 annual report stated there were 54 signatories accounting for 15 per cent of sales but the latest code statistics report there are almost 100 suppliers registered (Clean Energy Council, 2018). The Solar Retailer Code of Conduct contains a range of checks and protections for consumers. The code includes a detailed complaints process for investigating, managing and reporting on complaints and code breaches.

However, the code will be effective only if used by consumers to select accredited suppliers and if consumers use enforcement mechanisms for non-compliant signatories. Voluntary codes work where suppliers see them as essential for business and there is a credible risk of consequences for non-compliance (e.g. reputation damage). Our research found no awareness of the code and major dissatisfaction with solar suppliers amongst growers.

The CEC is currently updating the code and increasing resources for audit and compliance. The code will be released for public input. It is recommended the CEC and ECA engage with agricultural industry bodies to increase the awareness and effectiveness of the Solar Retailer Code of Conduct in regional areas.

Recommendation 9: State Governments should establish mandatory minimum retailer feed-in tariffs for solar.

The financial viability of renewable energy installations can be impacted by the grid connection to export electricity to earn feed-in tariffs during off-peak periods. However, retailer feed-in tariffs for solar PV are in general low, highly variable, there are many different offers to evaluate and there is effectively no scope for negotiation. In NSW, IPART sets a voluntary benchmark based on its assessment of the economic value of the output; the 2018 review shows only a handful of retailer offers are within the recommended benchmark.

In Victoria, the Essential Services Commission sets a minimum feed-in tariff for solar PV based on the economic value of the power (avoided wholesale purchases and network and retailer costs). The minimum rate is updated annually and now includes a time-varying tariff to reflect the change in value across the day between peak, shoulder and off-peak times.

If NSW or Queensland were to follow the lead of Victoria and set a mandatory minimum solar feed-in tariff based on the economic value of the exported electricity, this would reduce complexity and the transaction costs for growers, and support the financial viability of on-farm renewable energy.

Recommendation 10: Grower cooperatives and large users should be provided with support to investigate the feasibility of Renewable Energy Power Purchase Agreements (RE PPA)³.

Improving visibility in regional areas of the network and developing technical solutions will take time. Emerging options such as off-site RE PPAs have the benefit that they are located in areas of the network that can accept additional RE capacity, with the developer accepting responsibility for managing the relationship with the DNSP. Investigating the feasibility of RE power purchase agreements is a solution that should be developed for growers.

A growing number of organisations are signing power purchase agreements with RE generators (e.g. Telstra, Australia Post, Coca Cola, ANZ). Large agricultural energy users or cooperatives acting on behalf of their members could negotiate RE PPAs.

RE PPAs are a relatively new development in Australia. Some retailers are offering access to RE PPAs they have negotiated with a solar or wind farm as part of their offering – a trend likely to grow - but for most growers they would need to negotiate directly or through a cooperative with a RE developer. There are a range of costs, benefits, and risks that need to be understood and most are ill-equipped today to negotiate a RE PPA.

Consequently, education and feasibility assessment are required for growers to decide if a RE PPA is the right option for them. Funds to enable grower cooperatives to undertake a feasibility study, member engagement, and education on RE PPAs should be provided by state governments (such as the NSW Climate Change Fund or through the Queensland Renewable Energy Plan). Regional energy hubs would also be a natural platform for engagement (Prendergast *et al.*, 2018).

³ The Institute for Sustainable Futures has established the Business Renewables Centre-Australia in partnership with WWF and Climate-KIC – a not-for-profit initiative to support businesses assess RE PPAs. Funding has been provided by ARENA, the NSW Government, and the Victorian Government. See www.businessrenewables.org.au.

1 Introduction

1.1 Context

Electricity is an essential input for Australian agricultural production. Nationally, energy costs represent 11% of growers input costs (CBA, 2018). The cost of energy used by the Australian agricultural sector is estimated to be \$5.85 billion, with the cost of electricity at \$2.4 billion, equal to almost 10% of the gross value of production (Heath, Darragh and Laurie, 2018).⁴

The Australian Competition and Consumer Commission's (ACCC) 2017 inquiry into electricity prices concluded that rising costs are making Australian irrigated products less competitive. Electricity bills for irrigators increased by up to 300% between 2009 and 2014 (Agriculture Industries Energy Taskforce, 2017) and have continued to rise (Heath, Darragh and Laurie, 2018). An anticipated 50–70% rise in energy costs in 2017–18 for dairy processors could shave 1¢ per litre off the farmgate milk price if passed on, while growers at the same time are facing increases in their shed tariffs up to 20% (Dairy Australia, 2017).

Rising network charges are the key factor underpinning the increase in growers electricity bills, with regulated network charges and other costs represent half or more of growers electricity bills (Agriculture Industries Energy Taskforce, 2017). With the discontinuation of irrigation tariffs and the introduction of demand-based tariffs in Queensland and NSW, these prices are expected to increase further. Cost-reflective network tariffs could have a significant negative impact on the competitiveness of agribusinesses (NSW Farmers' Association, 2017; ACCC, 2018)

While many growers have invested in energy efficiency, water efficiency infrastructure has perversely saved water but increased energy consumption. Growers are increasingly investigating options to install RE to reduce their energy costs – a recent survey by the Commonwealth Bank found two-thirds of farmers want to install on-site solar and batteries - but have encountered a range of operational, economic and regulatory barriers.

One of the key barriers identified by growers is grid connection for on-site RE. Energy demand is highly variable for many forms of irrigated agriculture and therefore feeding excess energy back into the grid in off-peak periods has a significant impact on the financial returns and the size of system that can be installed. The complexity of grid connection processes (procedural barriers), the inability to connect, or limitations on export (technical barriers) have emerged as key barriers to the growth of RE in the sector.

1.2 About the project

The NSW Irrigators' Council (NSWIC), Cotton Australia and the Queensland Farmers' Federation (QFF) have commissioned this study to understand, document and provide clarity on how to better align grower and Distribution Network Service Providers (DNSP) interests in relation to grid-connected renewable energy. The study has been funded by Energy Consumers Australia.

⁴ The sectors included in the analysis were grains, beef, dairy, chicken, sheep, pork, eggs, and horticulture (vegetables, cotton, sugar, wine grapes).

The objectives of the study are to:

- Identify and record the challenges and obstacles experienced by growers who have installed renewable energy generation assets on farm, including those who have tried to feed excess energy generated back into the grid.
- Analyse and assess DNSP decision processes and connection applications with regard to technical/operational and process barriers that limit growers from feeding on-farm generated energy back into the grid.
- Assess the expected implications of new Chapter 5 amendments to the National Electricity Rules to assist embedded generators under 5MW to connect to the electricity distribution network.
- Identify and communicate possible future opportunities with the DNSP for renewable energy projects throughout rural Queensland and NSW with the view to better aligning growers and DNSP interests.

1.3 About the report

This report synthesises the findings from the case studies in the barrier summary report and the stakeholder workshop undertaken for this research project. It presents recommendations on actions to support the integration of on-farm renewable energy into the distribution networks. The aim of the recommendations are to:

- Increase the knowledge of irrigated growers on the opportunities, risks and challenges installing of renewable energy generation on-farm;
- Open dialogue between growers and DNSPs on partnership opportunities;
- Highlight policy/regulatory barriers across the two jurisdictions and program opportunities which can be addressed by government or energy industry stakeholders (for advocacy by agricultural representative bodies).

The object of the study was to develop mutually beneficial solutions for all parties - growers, DNSPs and rural communities.

1.4 Research approach

The study adopted a bottom-up evidence-based approach using a multi-method research design to collect information. The focus was on engaging with growers and DNSPs to understand their concerns and develop viable opportunities for them to work together. The research methods included a literature review, case studies, an online grower survey, and telephone interviews with the DNSPs (see appendix 1 for more details).

Four case studies were conducted across regional Queensland and NSW to explore these issues in more depth across a range of different crop types, irrigation practices, and water availability constraints and network constraints and opportunities. The case studies collected data through interviews and focus group discussions with selected growers. An online survey was administered to growers through member organisations. The combination of the three forms of data collection allowed for synthesis and triangulation of the results to gain a richer picture of the barriers and challenges experienced by growers.

There are two DNSPs active in the study area: Essential Energy in NSW and Energy Queensland in Queensland. Semi structured interviews were used to engage with both

DNSPs and growers. A workshop was organised to test the findings with representatives of the different stakeholders. The recommendations have been collated in the final report (this report).

The scope of the study was limited to distributed, on-farm RE systems with utility-scale RE not included. While the research started with a broader perspective on on-farm RE, solar PV was the most observed technology. Thus the report is based more towards solar connections.

2 Connecting Renewable Energy to the Grid: Benefits and Opportunities

Australia has a very high penetration of DRE by international standards. To date, this has primarily been driven by households but Australia is now in the early stages of a building wave of business RE investment. On-farm RE can reduce energy bills, increase budget and investment certainty and reduce the environmental footprint of produce for growers.

The Electricity Network Transformation Roadmap, developed by CSIRO and Energy Networks Australia, estimates consumers will determine how \$200 billion out of a forecast \$1 trillion of energy investment is spent by 2050. Distributed energy resources can require additional spending (e.g. network augmentation) but if effectively coordinated, they can reduce network costs by, for example, reducing peak demand or replacement expenditure on aging assets. Over \$16 billion in network expenditure could be avoided through effective orchestration of distributed energy resources (CSIRO & Energy Networks Australia, 2017). Therefore the way in which distributed energy resources are implemented will have a big impact on future electricity prices.

This section examining the drivers, benefits and opportunities for investing in RE by growers, and the scope for partnerships with DNSPs.

2.1 On-farm renewable energy: benefits for growers

Like other businesses, the interest of growers in installing RE is surging – fuelled by the growth in energy prices, the falling costs of RE and the foreshadowed shift to cost-reflective tariffs which could have a major impact on growers. A recent survey by the Commonwealth Bank found that rising energy costs were having a moderate to significant impact on the vast majority of growers and two thirds would like to invest in solar energy with battery to regain control⁵.

Distributed Energy Resources (DER) can help increase the resilience and sustainability of farming businesses by reducing energy bills, reducing exposure to future energy price increases and improving budget and investment certainty. There are three basic options:

- **Energy efficiency:** reducing energy consumption through more efficient technology or behavioural change.
- **Demand or load management:** using energy storage or making operational changes to change the time of energy consumption to lower-price times or to avoid network charges based on peak demand.
- **RE generation:** bio-energy, hydro power, small-scale wind energy, and solar PV. Solar PV in particular is now generally cheaper than grid electricity, scalable and can be integrated with a variety of agricultural energy uses. Solar PV can replace a significant proportion of the electricity and diesel currently used in rural water

⁵ Nearly half of growers said that they were already using solar without battery on farm (CBA, 2018). Another survey of over 1,300 growers across the country echoed this, with eight in ten growers supporting Australia moving towards 100% renewable electricity. More than 600 said they had installed solar power or battery systems on their property (FCA, 2016).

pumping (stock and domestic pumping as well as bulk water pumping for irrigation)⁶⁷.

When growers install RE, they should ensure the profile (time, peak, flexibility, etc.) of their demand is taken into consideration to get full value from the system (in terms of reducing energy costs). Electricity bills reflect two major components:

- Electricity network charges: around half of the typical bill results from the network charges, primarily based on the peak monthly demand.
- Electricity usage charges: around one-quarter of the typical bill is based on the retailer charges, which typically include a fixed daily rate and the energy used either on a flat rate or during off-peak, peak or shoulder times.

If a solar PV system is installed without using load flexibility or storage options to reduce monthly peak demand, it will reduce the energy usage charges but it might not reduce the larger network demand charge. Figure 5 illustrates the pitfalls with a real-life example from an agri-business at a site examined by ISF for another project. The blue-shaded output of the solar PV system did not reduce the peak demand (red block in black circle) which occurs earlier in the morning - and therefore did not reduce network demand charges.

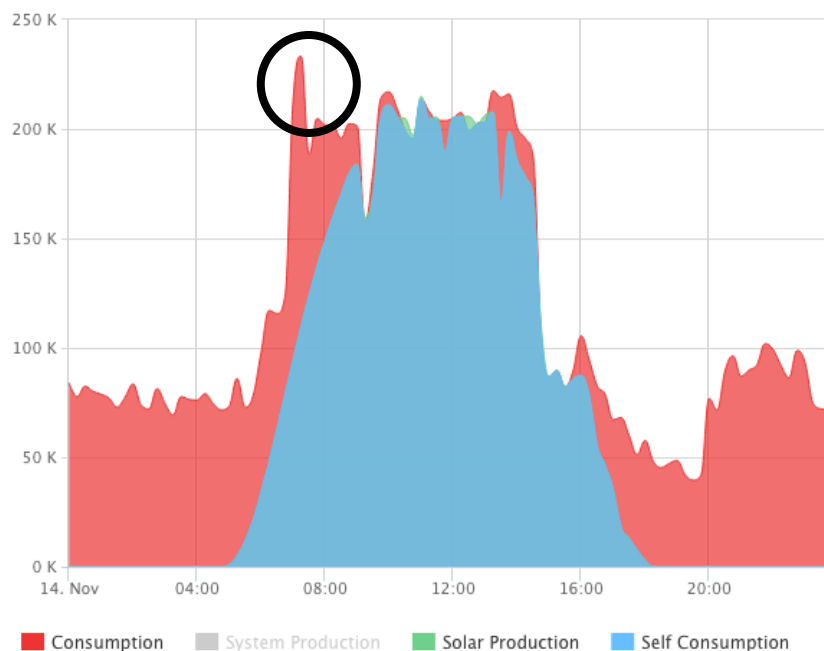

Figure 5: Solar PV & Load Profile

In this case, a small amount of load shaping or storage in combination with the solar PV system would have delivered a much better result. There are a range of options to enhance the value of solar:

- **Matching demand better with the orientation of solar:** Operations extending into the early morning or evening may be best served by extending the solar

⁶ Diesel generators are another option and rising energy prices has spurred their growth. However, the solar pumping guide from AgInnovators, notes that whilst solar PV is more expensive to install, they are cheaper over their lifetime than diesel systems due to the fuel costs (NSW Farmers and GSES, 2015).

⁷ Growers interested in solar PV for water pumping can consult the how-to guide published by the Office of Environment and Heritage (NSW Farmers and GSES, 2015).

generation profile through east-west trackers. Late afternoon peaks may be best addressed through west-facing solar.

- **Load shifting:** Where there is flexibility in operations, they can be shifted to make greater use of solar PV generation or flatten demand peaks to avoid network charges. Growers who have flexibility on pumping times can get extra value out of solar and effectively store energy in water reservoirs.
- **Storing PV output** to make use earlier or later in the day or at night. New storage and demand control technologies make it easier and cheaper for energy to be stored and used at different times without adversely affecting operations.
- **Managing existing systems:** There are often cheaper alternatives that already exist on-site. These include variable speed drives (ramping pumping up and down in concert with solar generation), cold storage and refrigeration (systems can be pre-cooled with solar PV towards the minimum set-points and then switch chillers off to allow the temperature to drift back upwards), and hot-water systems.

In relation to the electricity grid, there are three options for growers to access DER technologies:

- On-site systems that require no network approvals;
- Grid-connected solutions (with or without export); and
- Off-site energy products where other parties manage the grid relationship (such as renewable energy power purchase agreements where the energy user makes a contract to buy power for a set price from a solar or wind farm).

Table 1: Clean Energy Technologies and the Grid - the Pathways for Growers

Technology Category	Technology Type	Technology Location	Technology Description	Grid connection context
Energy Efficiency: using less power	Heating & Hot Water, Processing, Cleaning, Lighting, Controls, Behaviour Change, Pumps and Motors, Cooling	On-site	Technology options that can replace or upgrade existing systems to improve energy efficiency	No DNSP approval required
Load Management: changing the time of consumption	On-site storage (cool and heat storage), automated energy controls, batteries, flexible or discretionary uses.		Technology options that have the potential to store energy and therefore change the time of consumption. Changing the time of consumption can reduce network charges based on monthly peak demand, shift consumption to lower-priced times, and increase on-site usage of solar power by matching output with demand.	

Technology Category	Technology Type	Technology Location	Technology Description	Grid connection context
Distributed Energy Systems (Off-grid)	Solar pumping, ground mounted or rooftop solar PV, biomass, diesel generators, biomass/biogas generation, hydro, cogeneration/trigeneration		Technology options that generate energy near the source of demand but are <u>not</u> connected to the electricity grid. These can either use RE sources (e.g. solar or wind) or use fossil fuels (e.g. diesel or natural gas).	
Distributed Energy Resources (On-grid)	Solar pumping, ground mounted or rooftop solar PV, biomass, diesel generators, biomass/biogas generation, hydro, cogeneration/trigeneration, microgrids		Technologies that generate energy near the source of demand and are connected to the electricity grid. These can either use RE sources (e.g. solar or wind) or use fossil fuels (e.g. diesel or natural gas).	DNISP approval required
Commercial Arrangement	RE Power Purchase Agreement (PPAs), Virtual Power Plants (VPPs), local energy trading	Off-site	Off-site models for accessing RE. For example, under a RE PPA, growers can agree to buy power at a fixed rate for a longer-term (generally 7-years +) from a RE generator. Local Electricity Trading (LET) or Peer-to-Peer Trading (2p) is another example. Generation at one site is 'netted off' at another site, so Site 1 can 'sell' generation to Site 2, enabled by new technologies such as blockchain. LO3 is running a trial on p2p energy sharing in Renmark, South Australia; a small number of commercial buyers will bid for and trade energy generated by a local solar-and-battery provider, Redmud Green Energy (Bailey, 2017).	Approval managed by <u>other</u> parties

Whilst there are opportunities for growers to access the benefits of RE through off-grid and off-site models, the limitations of off-grid or off-site models at present are such that most growers require a grid-connected system:

- **Off-grid RE:** The variable character of many types of irrigation farming means there is a very large demand for 3-4 months and a much lower demand for the remainder of the year. Consequently, limitations on export can negatively impact the business case for renewable energy. Off-grid renewable energy with storage is an option, but batteries are currently not cost-effective. Off-grid renewable energy can also potentially work for crop types that have less variable load profiles. Otherwise, growers need to size systems to the off-peak demand (limiting its value) or accept lower returns from lower utilisation.
- **Off-site commercial models:** RE PPAs are growing in significance and there are cases of growers signing PPAs. However, at this stage they are relatively new and therefore can be complex transactions beyond the capacity of many growers. An emerging trend is retailers offering RE PPAs as part of their standard offer for 'market customers' with pass-through of the wholesale price for energy. This is a much simpler model and can deliver big savings. However, wholesale prices are volatile so users need to have flexibility through load management, storage or a diesel generator to avoid consuming grid electricity during high-price periods (Prendergast *et al.*, 2018) .

Consequently, grid connection is generally essential for most growers that want to access renewable energy.

2.2 On-farm renewable energy: opportunities for partnerships between growers & DNSPs

The integration of renewable energy creates technical challenges but also opportunities for partnerships between growers and DNSPs to reduce network costs through 'non-network' solutions – the use of alternative technology or demand management solutions with consumers to avoid capital investment or operating expenditure.

Two new schemes have recently been enacted to create an incentive for DNSPs to pursue non-network solutions: the Demand Management Incentive Scheme and Demand Management Innovation Allowance.

2.2.1 Demand Management Incentive Scheme and the Demand Management Innovation Allowance.

In December 2017, the Australian Energy Regulator (AER) established the Demand Management Incentive Scheme (DMIS) to enable DNSPs to invest in cost-effective demand management. The DMIS permits DNSPs to recover up to 50% of the cost of demand management projects from consumers where it will lead to lower costs overall. The Demand Management Innovation Allowance (DMIA) is a smaller fund (around \$20 million per annum) for innovative projects that are not presently cost-effective.

The scope of eligible activities for the DMIS and potential to avoid network costs is broad:

- **Capital Expenditure** e.g. projects that avoid network augmentation by reducing peak demand;
- **Operating Expenditure** e.g. cheaper solutions for voltage management. Scope exists for projects that can reduce the costs for integrating variable RE;

- **Replacement Expenditure** e.g. deferring or avoids replacement of aging assets such as switchgears. Scope exists for RE projects that reduce the energy throughput on lines with scheduled asset replacements.⁸

Partnerships between growers and the DNSPs that achieve reductions in these types of expenditure could leverage funds under the DMIS & DMIA.

Figure 6 illustrates the volume of funding each DNSP has available annually to spend on projects under the DMIA (striped) and the DMIS (colour block). Essential Energy can access around \$10 million per annum and Ergon almost \$15 million per annum.

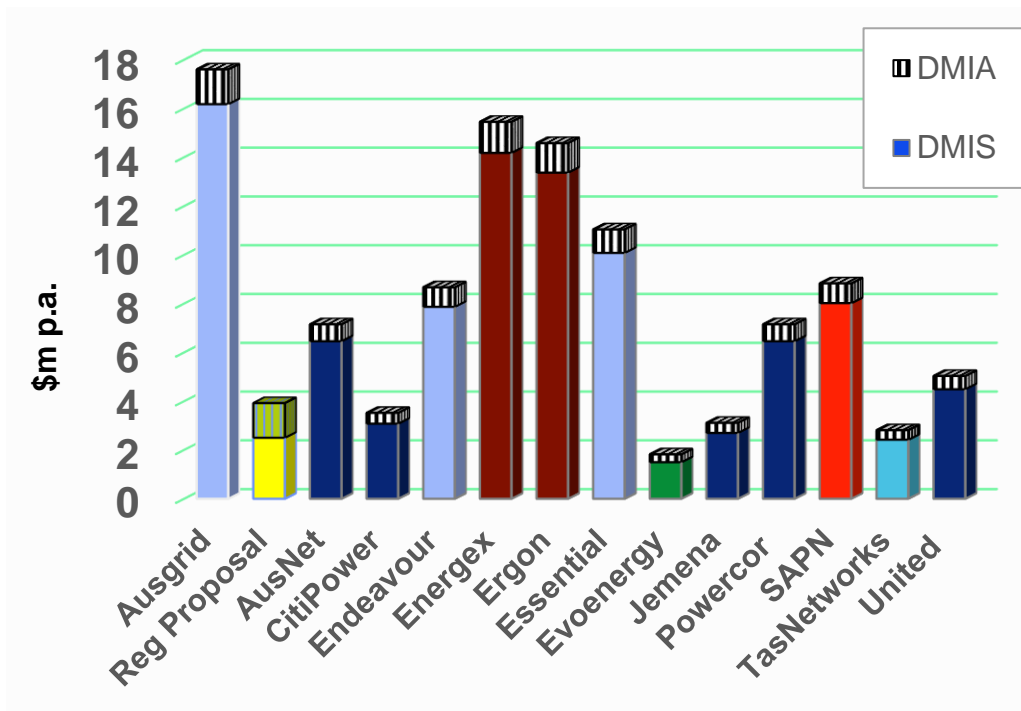

Figure 6: DMIS & DMIA, Additional Revenue for Network (\$m, p.a.) (Australian Energy Regulator, 2017a, 2017b; Ausgrid, 2018)

Some examples of the types of projects that could be funded through the DMIS or DMIA include:

- **Renewable Energy and Load Management (REALM) by Growers:** Use of load management could increase the output of RE that can be consumed on-site - reducing peak demand, extending the lifetime of aging assets or better matching supply and demand. DNSPs have not yet invested in behind-the-meter solutions but there is scope for pilot projects to test the role of REALM through DMIS and DMIA.
- **Solar PV & battery to support power quality:** Local power sources like solar may increase the range of voltage but controlling them strategically can enhance network power quality. Solar, batteries and other generators are connected to the grid through inverters. 'Smart' inverters have embedded internet-of-things (IoT) technology and a host of dynamic functions, allowing household generators to 'talk' to the grid, which can request dynamic support for services like voltage regulation. Smart inverters can provide these services to the grid, while managing the energy balance between solar panels, batteries and the household's energy demands.

⁸ For example, Ausgrid project (Ausgrid, 2018).

A trial in Collombatti, NSW (Figure 7) in Essential Energy's network under the ARENA-funded Networks Renewed project demonstrated the capacity to quickly regulate network voltage.

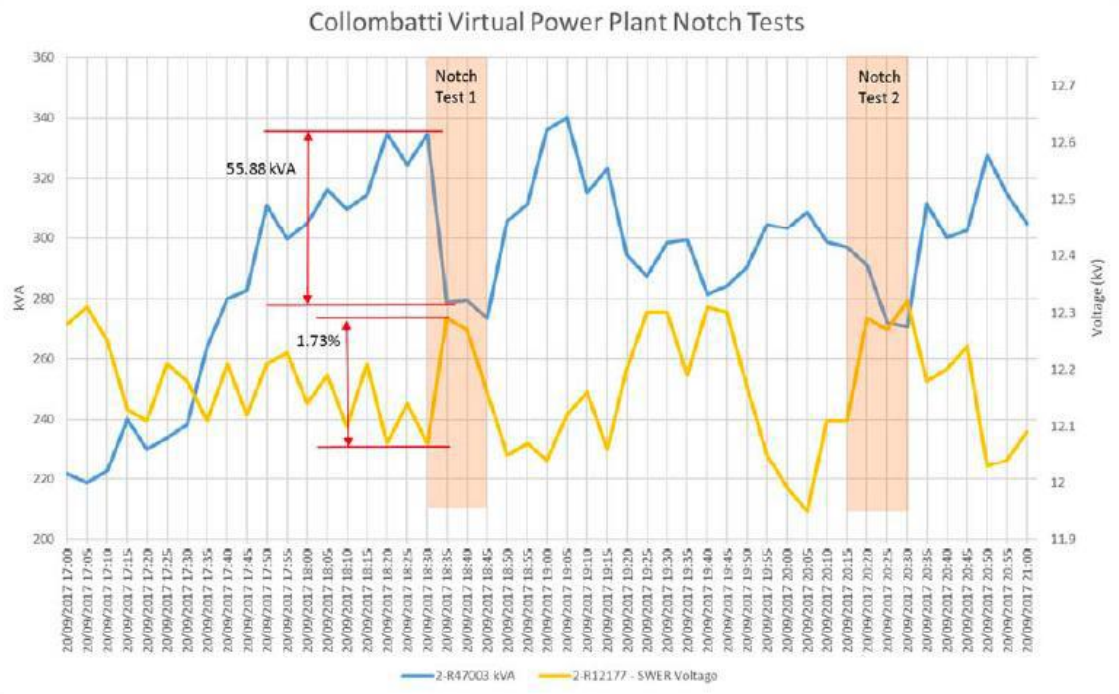

Figure 7: Trial Results (Institute of Sustainable Futures, 2018)

While, the trial was run with residential participants in the Essential Energy network, there is a potential to use combine smart inverters with PV (and battery) systems with growers in other areas and networks.

- **Embedded generation and microgrids:** Trials are demonstrating the technical and commercial feasibility for solar PV in combination with other technologies to provide grid support. For example, AusNet is trialling a micro grid in Mooroolbark, Victoria (to reduce peak demand); and United Energy and GreenSync are trialling a demand response and energy storage project on the Mornington Peninsula, Victoria to meet the seasonal increased peak load of 30% over the summer holiday period (this is forecast to defer around \$30 million of investment in new poles and wires).

2.2.2 Regulatory Investment Test for DNSPs (RIT-D)

There is an existing process under which DNSPs can apply to recover the costs of investments greater than \$5 million – the RIT-D. Under the RIT-D, DNSPs can apply to the Australian Energy Regulator to invest in solutions that maximise net economic benefit to meet an ‘identified need’ consistent with the service standards in the National Electricity Rules.

The Australian Energy Market Commission has considered RIT-D in the context of distributed energy resources. In theory, the RIT-D framework might support network investment in data and network augmentation to integrate distributed energy resources but in practice there is uncertainty about the eligibility and requirements for funding. In its 2017 *Distribution Market Model Review* (p.45), they also concluded it was ‘unclear’ whether DNSPs can invest in DERs - although in the 2018 *Economy Regulatory*

Framework Review the AEMC assessed that the existing framework could support efficient investments to improve understanding of low-voltage networks.

However, as the AEMC further notes, there have been no RIT-D applications for these types of investment and further guidance is required to establish investment certainty.

2.3 Conclusion

There are strong drivers for growth in the uptake of renewable energy amongst growers. The growth of renewable energy can present a range of technical challenges for DNSPs which were not designed for two-way flows of power. However, a range of early-stage trials and pilots are also highlighting opportunities for partnerships to integrate renewable energy and are establishing that renewable energy can benefit both the DNSP and the consumer. Processes, mechanisms and demonstrated applications still need to be established for DNSPs to successfully integrate renewable energy.

3 Connecting Renewable Energy to the Grid: Regulatory and Policy Context

In 2014, a new process was established within the National Electricity Rules to make it easier for proponents to connect renewable energy generators under 5MW (Chapter 5A). However, a series of reviews have highlighted that grid connection processes under Chapter 5A is currently inefficient, complex, costly and inhibits competition and innovation. The current network access arrangements have negative impacts that include:

- Higher costs for renewable energy installations (through increased time and connection costs).
- Barriers to the adoption of new decentralised energy technologies (including storage, demand management equipment, charging infrastructure) and reduced competition from limiting new entrants⁹.
- Investment uncertainty: Projects are sometimes abandoned or not proceeded with due to uncertainty, costs, delays, or rulings by DNSPs that the network either cannot accommodate more RE at all, or with significant conditions that impact on the viability of the project.

Energy Networks Australia has responded by coordinating the development of guidelines to streamline connection processes from micro to large-scale generation.

Before outlining fieldwork results, Section 3 provides an overview of the grid connection process, reviews of Chapter 5A and the issues identified for energy users seeking to connect RE to the grid.

3.1 Connection regulations: National Electricity Rules

Grid connection is regulated primarily by Chapter 5 and 5A under the National Electricity Rules and secondarily by state-based legislation. There is a set of basic obligations on both the applicant and the DNSP:

- DNSPs operate under an 'open access' regime where they are required to review and process applications to connect but not to provide guaranteed access to the network.
- Both DNSPs and proponents have an obligation to negotiate in good faith. The DNSP must consider applications in a timely fashion and applicants must provide the information reasonably required to assess the application.
- DNSPs must maintain network security, safety and reliability consistent with the NER and state legislation.
- The applicant has an obligation to comply with reasonable requirements of the DNSP.

⁹ Climateworks (2017) state equipment manufacturers chose not to participate in the Australian market because of the costs of participating and network access,

- DNSPs are required to publish an information pack on their website outlining the technical requirements for grid connection and a public register.

There are two pathways for connection:

- Chapter 5: originally applied to generators with capacity greater than 5MW but generators under 5MW can also elect to use Chapter 5
- Chapter 5A: a shorter, more flexible process designed to apply to generators under 5MW

Under Chapter 5A, there are three connection processes:

- Basic connection: micro-generation (<30kW) where there is minimal or no network augmentation
- Standard connection: non-micro generators for which there is an Australian Energy Regulator (AER) model standing offer (30kW – 5MW)
- Negotiated connection: all other distributed generation applications

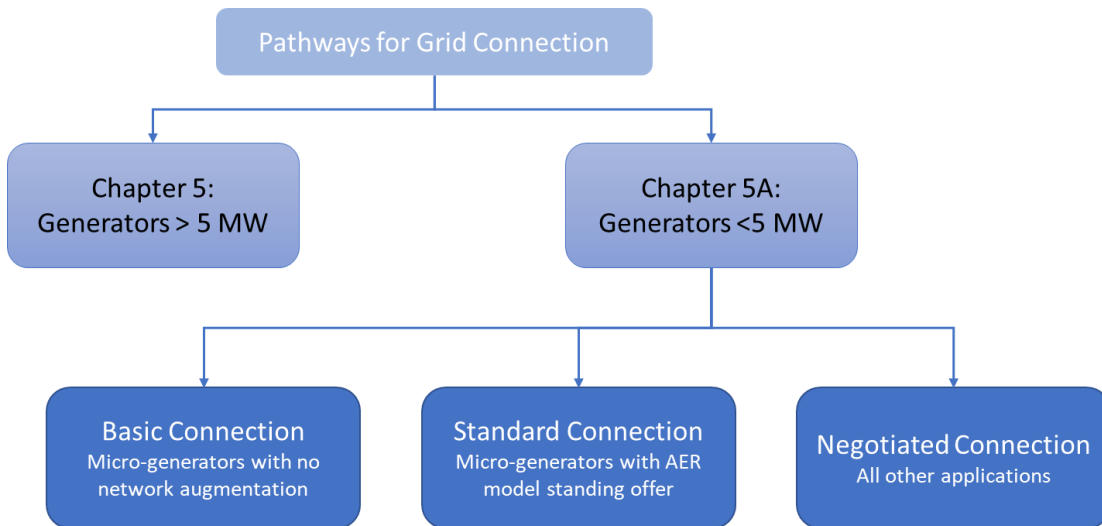

Figure 8: Pathways for Grid Connection

In practice, the majority of applications are assessed as negotiated connections.

Figure 9 summarises the process for negotiated connections. The key phases are:

Preliminary enquiry: In this phase, DNSPs provide prospective Connection Applicants with specific information and advice in relation to the connection process and requirements associated with establishing a new or altered connection or a relocation of existing network assets. This service is for initial advice and excludes more detailed investigations/advice which may subsequently be required from strategic planning studies and analysis and process facilitation (Essential Energy, 2015).

Detailed enquiry: is used to request general information regarding connecting to the network; to confirm if power supply is available; or to request a Budget Estimate (Ergon Energy Network, 2018). In this phase, DNSPs might undertake planning studies and associated technical analysis to determine suitable/feasible connection options for further consideration by proponents. The service applies mainly to large loads and generators where suitable connection options are not necessarily obvious and may result in potentially significant impacts on the existing network development strategies and augmentation requirements (Essential Energy, 2015) A Detailed Enquiry will not establish a connection to the network, a connection application needs to be filed.

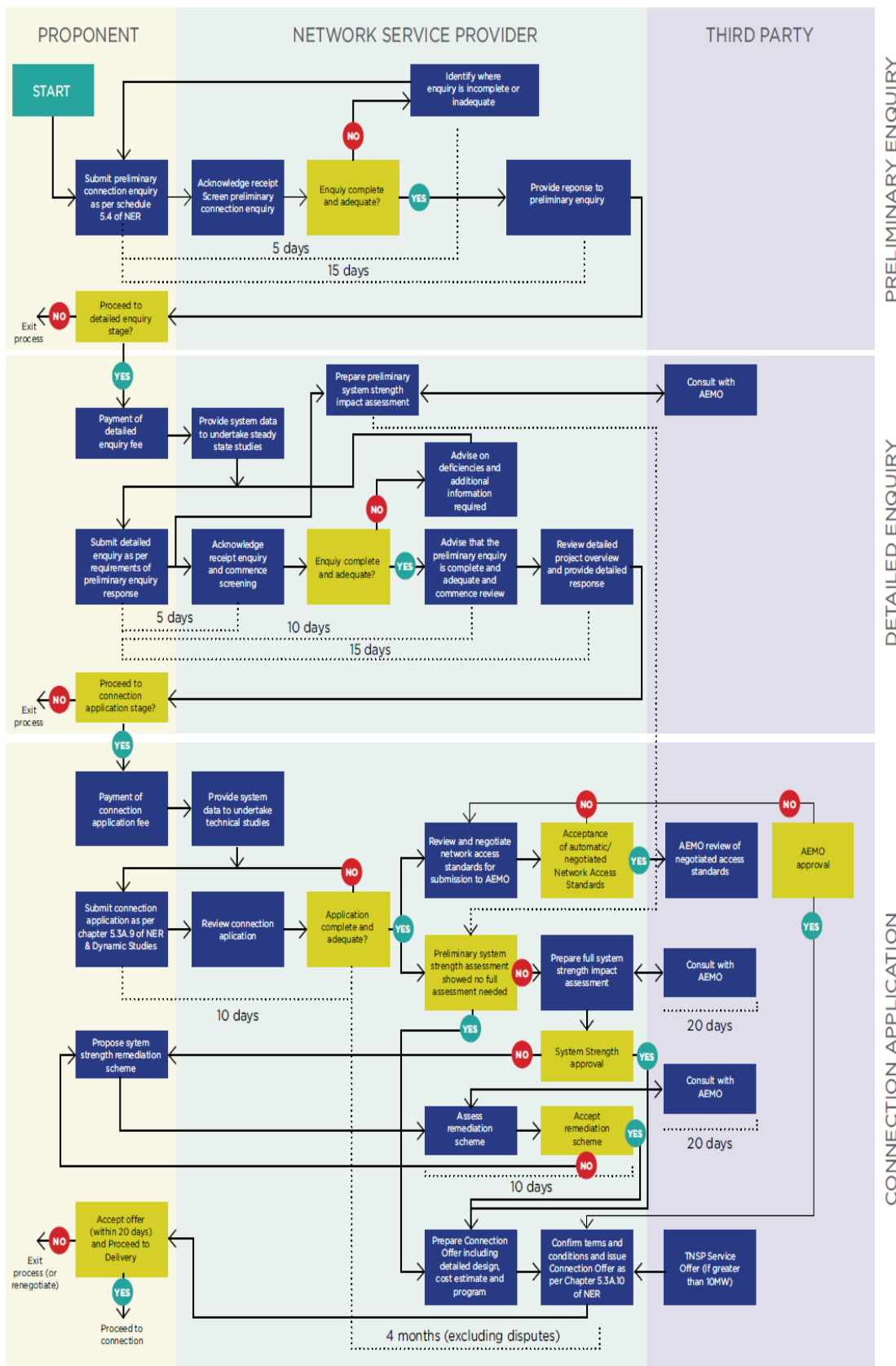

Figure 9: Registered generator connections process (distribution connected)(ENA, 2018)

The AEMC rejected a range of proposals from the CEC to introduce further regulation of the connection process in the 2014 rule change including:

- Standard connection agreements for mid-sized technologies (solar, co-generation, hydro).
- Firmer rules on process timeframes for networks.
- Information provision.
- Connection fees.
- Technical performance standards to find alternatives to export limitations and dispute resolution.

Consequently, the grid connection process is lightly regulated with significant discretion and variation for DNSPs:

Technical standards for grid connection are developed and implemented by DNSPs in a largely self-regulated framework, resulting in inconsistencies between DNSPs in terms of structure, clarity, coverage and onerousness of technical requirements. There is still no prescribed overarching governance framework or agreed structure for the DNSPs guidelines nor any guidance as to how the technical requirements should be set as to adequately balance network risks of safety, voltage, stability and capacity issues with connection efficiency (Energeia, 2016).

There is no body or mechanism with oversight of grid connection processes to ensure the balance is being struck between network security, consumer interests and fair competition (Climateworks Australia and Seed Advisory, 2018).

There are some variations between NSW and Queensland which reflect differences in state regulations¹⁰ - the requirement in NSW for Accredited Service Providers (ASP) to undertake works (the Accredited Service Provider and Contestable Works Scheme (Department of Planning & Environment, 2017) - and differences in approach between the networks. In NSW, the services required to establish a customer's connection to Essential Energy's network are undertaken by ASPs as contestable services. In Queensland, the DNSP manages the tender process. The ASP is designed to offer the consumer more choice when tendering for connection works.

However, the building blocks of the connection process are quite similar in both states.

3.2 Chapter 5A: reviews

A series of reviews have investigated grid connection processes under Chapter 5A (ClimateWorks Australia, Property Council of Australia and Seed Advisory, 2015; Energeia, 2016; ClimateWorks Australia and Seed Advisory, 2017; Climateworks Australia and Seed Advisory, 2018; ENA, 2018). The NSW Government also commissioned a review of NSW transmission and DNSPs with recommendations for improvement (CutlerMerz, 2018).

The findings of these reviews are broadly similar, each identifying a range of barriers for users trying to connect RE as summarised in Table 2.

¹⁰ Specifically the NSW Code of Practice for Service and Installation Rules & Queensland's Electricity Distribution Network Code

Table 2: Key Issues identified in Chapter 5A reviews

Issue	Description
Information	<p>Inconsistent technical and information requirements between networks: different standards and processes add to complexity and transaction costs. Equipment that is acceptable to one DNSP is not always accepted by another DNSP.</p> <p>Ambiguous requirements: distributor guides can refer to multiple standards which have inconsistencies, use ambiguous requirements and non-committal language that did not provide certainty.</p> <p>Common communications platform: the absence of a single platform where all relevant information could be found.</p> <p>Information on the reasons for decisions: information on reasons for unsuccessful applications to provide guidance for future applications is not always provided or communicated.</p>
Connection processing time	<p>Connection process timeframes could be lengthy with insufficient guidance.</p>
Connection fees	<p>There are a variety of connection fees that can be levied. These include:</p> <ul style="list-style-type: none"> • Enquiry fee; • Connection assessment fee; • Application fee; • Cost of minor deviations from Standard; • Other incidental costs • Investigations • Augmentation (including equipment such as a transformer) <p>Some applicants have found significant variations and unexpected increases in costs.</p>
Service standards	<p>Some reviews have found variable approaches within networks: In the context of ambiguous requirements, similar requests or issues can be dealt in quite different ways by different personnel depending on their approach, skill and experience.</p>
Queueing	<p>Processes for ‘queueing’ of applications: reviews found there is a lack of clarity as to how are applications at the same location processed, especially where there are constraints</p>
Managing network constraints	<p>Processes for managing impacts on local network hosting capacity: there are different approaches for determining limits and managing connection applications where limits are identified. Some networks have clear rules whereas others apply a case-by-case approach with little information to guide applicants.</p>
Network augmentation costs	<p>Equity of process for allocating costs of augmentation: there is no effective mechanism to address the “last in, worst dressed” approach to the costs of upgrading a local network’ which falls upon a connection proponent after others have used up connection capacity.</p> <p>Efficiently managing network augmentation costs: there are a variety of procurement processes for augmentations which are not necessarily competitive and where investment in response to specific connections is not necessarily efficient</p>
Islanding	<p>Islanding is rarely permitted: a property could continue to self-generate after network failure.</p>
Dispute resolution	<p>No effective access to dispute resolution: dispute resolution processes do not apply until a connection agreement is offered and few proponents use dispute resolution processes. The discretion of networks in processing applications and the potential for reputation damage has been offered a reason.</p>

There is broad agreement across major reviews of grid connection processes under Chapter 5A that network access arrangements have had negative impacts including:

- Higher costs for RE installations (increased time and connection costs);
- A barrier to entry and the adoption of new decentralised energy technologies (including storage, demand management equipment, charging infrastructure);
- Lower uptake of RE: projects are sometimes abandoned or not proceeded with due to uncertainty, costs, delays or rulings by DNSPs that the network either cannot accommodate more RE or with significant conditions that impact on the viability of the project;
- Under-sizing of RE projects: projects are sized within the load profile of the site to avoid export.

There is also recognition that the existing arrangements have created problems for network businesses trying to process the rapidly growing volume of connections (e.g. issues with the quality of applications).

3.3 Towards Harmonisation: Energy Networks Australia Connection Guides

A common feature of all these reviews was the finding that inconsistencies and uncertainty in grid connection costs was imposing significant costs on consumers and DNSPs. Each of these reviews recommended greater harmonisation, use of common standards and transparency of grid connection standards.

The study by (Energeia, 2016) commissioned by the CEC recommended an industry-led approach to develop a national connection guideline. Based on international experience, Energeia recommended a tiered approach with a national standard setting a framework for implementation by DNSPs to reflect local circumstances.

Energy Networks Australia (ENA), the peak body for transmission and distribution networks is currently overseeing a process to develop standard guidelines for different connection types for each of the different connection types (micro, low-voltage etc.).¹¹ There is agreement between the CEC and the ENA there is a need for greater clarity and standardisation on connection processes to facilitate RE:

Each network has responded to these challenges independently, resulting in a range of technical requirements and connection processes which, although consistent with local regulatory requirements, result in some inconsistencies between networks and a lack of clarity for proponents ... This lack of clarity causes confusion with regard to the technical requirements needed for systems to connect to the grid. This has resulted in a large proportion of customer inverters being installed with settings (e.g. frequency trip settings) outside those stipulated in the connection agreement between the customer and the network. This in turn has led to systems not operating to their full potential in integrating with the grid and consequently, full value not attained for the customer (Johnston, 2018)

In collaboration with the DNSPs and other stakeholders (including the CEC and Energy Consumers Australia), the aim of the model connection guides is to establish clear and consistent guidelines, a level of consistency between technical requirements, and balance consumer interests with network security.

The guidelines are voluntary. All networks are participating and will apply them as they consider best for their system. Mandatory guidelines will be considered in reviews of

¹¹ A study by (Energeia, 2016) commissioned by the Clean Energy Council recommended an industry-led approach to develop a national connection guideline. Based on international experience, Energeia recommended a tiered approach with a national standard setting a framework for implementation by distribution networks to reflect local circumstances.

the guidelines which will occur every 2 years and include a range of stakeholders such as the Clean Energy Council. The first overarching framework has been released and other frameworks are scheduled for release in 2018/19.

3.4 Voluntary Codes: Networks, Retailers and Installers

There are other regulations and standards that apply to network connection standards and arrangements.

- **State regulations** apply in each jurisdiction which address technical aspects of network operation not covered by the National Electricity Rules (specifically NSW's Code of Practice for Service and Installation Rules & Queensland's Electricity Distribution Network Code).
- **Australian Standard AS477** – Australian Standard for the grid connection of energy systems via inverters.

Alongside State and Federal regulations, there also voluntary codes which shape the grid connection process. There are two relevant voluntary industry codes overseen by the CEC for parties that manage connections on behalf of growers:

- **Solar Retailer Code of Conduct:** the purpose of the code is to promote best practice amongst suppliers of solar PV systems. The code encompasses pre-sale and post-sale service issues (e.g. misleading claims) and requires signatories to provide 5-year whole-of-system warranties.¹² Only parties that have operated for at least 12 months can be signatories, there is a complaints process and an audit and compliance program. The code has been authorised by the ACCC.
- **Clean Energy Council Accreditation for solar designers and installers:** to be eligible for incentives under the Small-Scale Renewable Energy Scheme, the installer must hold CEC accreditation. Accreditation requires installers comply with relevant standards and regulations.

3.5 Conclusion

The connection of RE to the electricity grid is regulated by a complex mix of standards and regulation including the National Electricity Rules, state legislation, voluntary codes. Each network has developed its own approaches to grid connection. Consequently, the grid connection process can be challenging for consumers.

¹² Around 90 retailers are signatories and the list of those that comply with the code can be found at: <http://www.solaraccreditation.com.au/retailers/approved-solar-retailers..>

4 Connecting Renewable Energy in the Irrigation Sector: Key Challenges

This section presents key findings from the case studies. Four case studies were undertaken: in Bundaberg and the St George in Queensland, and Narrabri and the Murray/Murrumbidgee irrigation district in NSW as seen in Figure 10. The selection of case studies was designed to maximise diversity in terms of geography, crop types, irrigation practices, water availability and constraints and network constraints. The difference in climate zones and agricultural practice have an impact on the electricity demand.

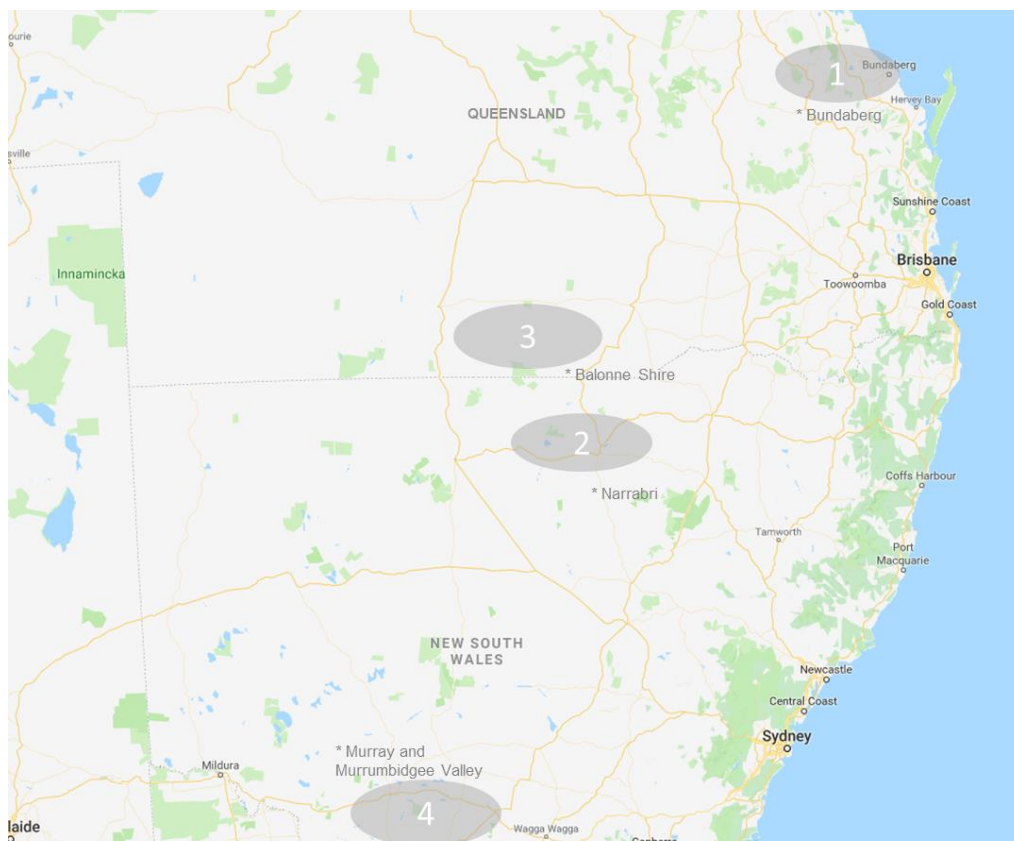

Figure 10: Connecting renewable energy in irrigation districts - approximate location of case study areas (not to scale)

Through the case studies, the grid connection process is considered from the perspective of growers (4.1) and DNSPs (4.2). It is important to understand both perspectives to find mutually acceptable solutions.

4.1 Grid connection for renewable energy: barriers for growers

In this section, the connection process for growers in practice is detailed before looking at the barriers reported by growers. There are some important features of how the connection process works in practice that are not obvious from the high-level grid connection flow diagrams; in particular, there is very little direct contact between growers and the DNSPs. Understanding how the process works in practice is important for the findings on the barriers and how the process can be improved.

4.1.1 Grid connection for RE: how the process currently works for growers

The first finding from the case study research was that there is generally no direct relationship between the DNSPs and growers; grid connections are managed by a range of third-parties for growers (either the solar supplier, an installer or consultant). The third-party that mediates the relationship between the growers and DNSPs is usually selected when growers are purchasing the RE system. The issues and barriers identified by growers stretch across the process of installing and connecting RE generation assets, both before and during the involvement of the DNSP for the network connection process. The lack of independent information or support for growers when they select the RE system and a suitably qualified supplier - who will also generally manage the grid connection process – and the subsequent confusion and mistrust on suppliers was a very strong theme throughout the research. Consequently, solutions need to encompass solar suppliers as well as the DNSP and grower relationship.

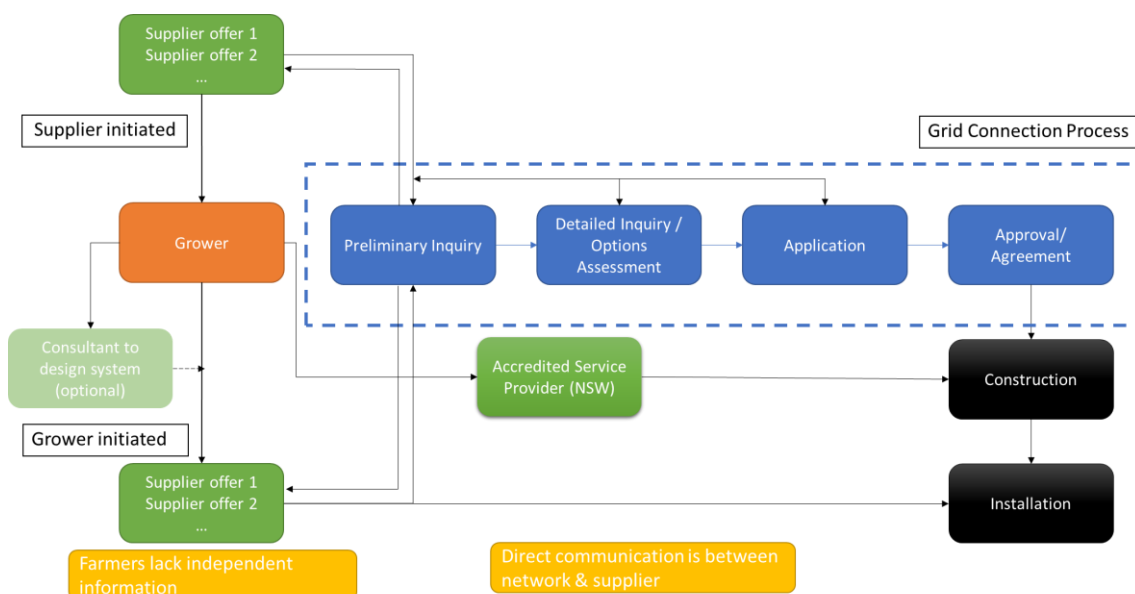

Figure 11: Installing and Connecting On-Farm Renewable Energy

The research revealed that RE projects are initiated mostly by suppliers and sometimes by growers themselves. Figure 11 illustrates the process growers follow to install and connect on-farm RE systems.

In the supplier-initiated approach, supplier(s) reach out to farmers to sell solar PV systems. This is often through cold-calling which leaves growers confused, mistrustful and many decide it's too difficult or too expensive to proceed with the installations of solar PV systems on farm. The grower-initiated approach was less commonly observed. In some instances, consultants are engaged to assist the design and

integrate the RE system with the existing farm equipment. Here the growers approach the supplier(s) in a more informed manner. Though in both approaches the supplier is the key contact with the DNSP.

There are variations between the approaches of the networks to managing assessment of RE connections. However, the building blocks of the process in both jurisdictions are similar with one major difference: in NSW connection works are undertaken by accredited service providers (ASP) under a contestable works scheme whereas it is managed by the DNSP in Queensland. The ASP approach offers greater competition but also adds another party that mediates the relationship between the DNSPs and growers.

It is important to note there is effectively no process for network-initiated projects for distributed energy resources (DERs) that could be identified at this stage. The emergence of DERs creates opportunities for networks to initiate projects with growers that can reduce capital, operating and replacement expenditure. It is generally accepted that DERs will likely deliver network benefits in the future, but the pathway to that future is yet unclear. DNSPs are still in the process of experimenting with and assessing DER based network solutions.

4.1.2 Grid connection for RE: key challenges and barriers

Overall, our research into grower perspectives found similar issues to those identified in past reviews of Chapter 5A. However growers are different customers to households or other small businesses. The variable demands and the integration requirements with existing equipment creates complexity. In addition there were other issues with other parts of the installation process such as solar suppliers that gave rise to disputes. The matrix in Table 3 attempts to summarise the different challenges growers shared over the course of the case studies. It is important to recognise that though the research question was focussed on the grid connection approval process, energy is a complicated issue and many other barriers were brought up by growers. Challenges are grouped across the three key steps growers undertake to install on-farm RE with grid connection as the central theme.

- **Pre-connection:** the preliminary phase that includes planning and designing the system. The key stakeholders the growers engage with during this phase are equipment suppliers and / or consultants. Growers assess the economic viability and sources to fund the system. This involves the preliminary enquiry step depicted in Figure 11.
- **Grid Connection:** This phase comprises the engagement between the DNSP and the representative of the grower to negotiate a grid connection approval. This is guided by steps laid out by the NER and the DNSPs. This involves the detailed enquiry, application and approval stages depicted in Figure 11.
- **Post-connection:** This is the final phase in the lifecycle of the process. It includes dispute resolution and redressal if any. Many growers do not actively participate in this phase. This is beyond the process depicted in Figure 11.

Table 3: Summary of barriers reported by growers and agribusinesses

Process	Technical	Economic	Information/ Communication
<p>Pre-grid connection (planning & sale)</p>	<p>System integration and upgrades</p> <p>Old irrigation equipment can require upgrading for integration with RE adding complexity and cost</p> <p>Logistics and geography</p> <p>Bores & pumping station are usually dispersed across the farm – not every site has existing grid infrastructure & difficult to access</p> <p>Suitable land not always available for RE system at the bore sites or pumping stations</p> <p>Hosting capacity and export thresholds</p> <p>Limited information for growers on the hosting capacity and export thresholds for local network when planning RE system</p>	<p>Financial viability of solar for variable irrigation loads</p> <p>Biggest issue for cotton and cane growers – irrigation runs for 4 to 6 months so no value for the remainder of the year without grid export</p> <p>Energy storage systems like batteries are too costly</p> <p>Concern about the payback timeframe</p> <p>Tariffs</p> <p>Uncertainty about changing tariff structures (time of use, demand driven tariff) in Queensland create uncertainty on the business case for RE.</p> <p>Low feed-in tariff from retailers</p> <p>Rising fixed costs and demand charges for network services</p> <p>Other financial issues</p> <p>Younger growers can't afford up-front capital costs of solar (even though diesel may be more expensive over its lifetime)</p> <p>Higher cost of quality systems and equipment</p> <p>Consolidating pumps on one meter can push growers over the large consumer threshold and lead to higher demand charges</p>	<p>Information gaps of solar installers</p> <p>Growers consider few understand solar-pumping integration or agricultural equipment and loads more generally</p> <p>Availability of technology, return on investment</p> <p>Trust and service issues with solar suppliers</p> <p>Low trust and reports of malpractice by suppliers</p> <p>Lack of information on quality of third-parties</p> <p>Third-parties generally manage process from sale to connection but little information for growers to distinguish good from bad</p> <p>Grower understanding of solar</p> <p>Gaps in knowledge about energy systems which is not a core priority for growers</p> <p>Innovative models</p> <p>Growers are not sure who to talk to about innovative energy models</p>

Process	Technical	Economic	Information/ Communication
<p>Grid Connection (Preliminary & Detailed inquiry Stages)</p>	<p>Hosting capacity of the Network</p> <p>In some areas (St George and Dirranbandi) there was limited to no capacity for exporting to the grid</p> <p>Export limitations (partial or full) applied in other areas due to network assessment of thermal or voltage/ frequency limits</p> <p>Decision Making by the DSP</p> <p>Low visibility and static modelling by the DNSPs on technical limits within local network make the decision making process more opaque and possibly outdated</p> <p>Queuing of applications</p> <p>Concerns and lack of understanding on how previous / dormant applications affect approval chances and export limits assigned</p> <p>Similarly, with large solar farms coming up, concerns about hosting capacity left over for small connections</p>	<p>Process costs</p> <p>Significant increase in costs for increased export capacity on certain feeders (Augmentation Expenses)</p> <p>The scale of modelling and specialist assessment costs are sometimes considerable</p>	<p>Limited direct involvement of growers</p> <p>Connections are usually managed by a third party which adds a further layer to the relationship. Information from the DNSPs is not always being conveyed.</p> <p>Communication to improve system design</p> <p>Lack of feedback and recommendations for better placement or scale of the project – which leads to several rounds of application without a guarantee of the success of the next step</p> <p>Communication on process</p> <p>Different experiences on responses about who can approach DNSP for initial information – the grower or the supplier</p> <p>Lack of clarity about specific processes within DNSP</p> <p>Frequently changing contact persons within the DNSP</p> <p>Communication on reasons for decision</p> <p>Lack of transparency about the decision of the DNSP – the feedback only contains the capacity approved to export without explanations</p> <p>Export capacities seem to be assigned / negotiated arbitrarily</p>
<p>Dispute resolution</p>	<p>No use of dispute resolution processes – either for grid connection or the conduct of solar retailers. No evidence of awareness of codes amongst growers designed to improve service standards.</p>		

4.1.2.1 Technical Challenges

Growers face a range of technical challenges in installing RE across the lifecycle of projects, both before and during the network connection process.

System Design, Farm Integration adds complexity and cost

Integrating RE systems into farm settings is often more complex than for households or commercial buildings. Integrating RE systems into existing irrigation setups, is particularly challenging, due to the variation in demand from 24/7 power requirements to none in the non-growing seasons. Energy use and patterns are also influenced by the water demands of the crop at particular times, local weather and soil conditions, water sharing plans and schedules, etc. Thus it is important to understand the irrigation system, before attempting interventions. For example:

- *Spatial integration*: irrigation pumps and bores are often dispersed across fields and may not be connected to grid infrastructure, making them difficult to access.
- *Operations integration*: in both states it was observed that irrigation equipment was often dated and integration with irrigation needs and existing equipment increases the complexity and cost. Skill gaps in consultants: combined expertise in farming and RE is hard to find

There is a lack of personnel who are knowledgeable about integrating RE system with farm equipment. It was reported that consultants understand either RE or irrigation systems – but few have expertise in both. Water access conditions associated with water licences and the operational constraints of irrigation channels for example were also not well understood by equipment/system providers. The importance of combined expertise was highlighted by some of the successful projects identified in the case studies.

Network Constraints

There are technical constraints which can limit the size of RE systems that can be connected to the grid or the exports that can be made. Export limitations may be put in place either due to the lack of thermal capacity (VA) to accommodate higher power flows or other power quality issues (voltage, power factor, harmonics, fault current limits) on that part of the grid.

Currently DNSPs¹³ often have low visibility of network hosting capacity for RE at the low voltage level in regional areas where growers are seeking to connect. Networks need to ensure adding RE will not exceed thermal and voltage limits in low-voltage lines. This may lead to limitations on grid export that are more conservative than necessary or require further investment where there are physical constraints. As such, some growers are required to design their RE system so that it cannot export to the grid. This often requires more system complexity and cost to the grower.

Growers were also concerned that large solar farms being developed in regional areas would squeeze out their capacity to connect to the grid.

4.1.2.2 Economic Challenges

Across the 4 case studies, the opportunity to reduce energy bills and have more control over energy costs was the prime motivation for growers to consider the installation of RE systems on farm. Solar power is generally understood to be cheaper across the project lifecycle as compared to diesel generators or grid electricity. However, there

¹³ The research focussed on two predominantly regional DNSPs; Ergon Energy in Queensland and Essential Energy in NSW

were other factors that can impact the financial returns to growers or create investment uncertainty that prevents growers from proceeding.

Upfront capital costs

In both NSW and Queensland, the upfront capital costs and payback periods were an impediment. Discussions with growers in both states found that growers did not always value RE systems in the same way as other investments (e.g. decision making on payback period vs rate of return¹⁴) and therefore placed a higher weighting on the upfront capital cost. This was especially the case for young growers starting out, as there are competing demands on their capital.

Investment uncertainty: network tariffs, connection costs and export limitations

Network processes can add to the investment uncertainty in a number of ways.

Firstly, there is uncertainty around future tariffs. In Queensland, particularly the uncertainty around the loss of transitional and obsolete tariffs in 2020 as well as future tariffs over the next regulatory period was a major deterrent for growers to commit to an investment in RE. There is speculation that the costs / charge associated with grid electricity tariffs may fall reducing the returns from RE.

Secondly, the uncertainty of the additional costs of connecting to the grid and the potential for export limitations was another factor that created investment uncertainty and deterred growers. This was especially so for those with large variable irrigation loads. Connection costs are generally for systems that want to export excess electricity to the grid, but in some instances, growers have had to pay to install grid protection systems, to prevent back flow into the grid.

Costs for technical assessments and network augmentation

In cases where the grid infrastructure need to be upgraded or augmented to accommodate the connection of RE generation assets to the grid, it is generally the case that the responsibility for the associated costs fall partially or completely on the grower. Also, the current system is a 'last-in, worst-dressed' process where past applicants do not pay and the costs fall on the applicant that experiences the constraint. There is uncertainty about the timing and quantum of any cost recovery where it applies for later connections. Growers in both states reported the cost of paying for technical assessments of the feeder was another barrier.

Low retailer feed-in tariffs

In general, the low feed-in tariff rates paid for export leads most installers to size RE within the maximum site demand. Since the financial incentive is low, growers choose to have smaller systems that only meet their on-farm demand, without exporting electricity. However for irrigators with high energy usage for 4-6 months of the year grid connection might be essential for export during months when there is no on-site demand. Low retailer feed-in tariffs also impact on financial returns even where grid connection is secured.

Awareness and use of available finance

Access to finance was not noted as a major challenge in any of the case studies, but there seemed to be limited awareness of available funding support such as concessional loan facilities established by banks with the support of the Clean Energy

¹⁴ There are pros and cons with use of different metrics. In general, rate of return is more accurate as it calculates total costs and benefits. However, projects with shorter payback periods do not always deliver the best return over their lifetime. Farmers use rate of return on other investments and use of payback period is a factor in lower take-up.

Finance Corporation (CEFC). Most growers who had installed solar reported either self-financing the system or were offered a payment plan by the supplier.

4.1.2.3 Information & Communication Challenges

Lack of trust in suppliers

One of the most pressing challenges shared by growers was the lack of trust in suppliers. Growers report that they had been misled and cheated by unscrupulous suppliers. This was a common theme in both states. Growers were unsure of whom to trust and identified the lack of independent advice and reliable information on different equipment and technologies available in the market as a key barrier to proceeding with the installation of RE systems.

From the perspective of the networks, the key problems arise from inadequate information provided by the third-parties that manage the connection process for farmers (and therefore create delays in the approval process).

Communication between DNSPs and Growers is not working well

In both NSW and Queensland, it was observed that growers are not directly engaged with the DNSPs. This engagement is often facilitated by third parties, generally the supplier, and the ASP in NSW. From the DNSP perspective, the third-party managing the connection is the 'customer' and communication with growers is the responsibility of the third-party. However, the current situation is creating high levels of confusion, frustration and misunderstandings of process requirements and outcomes for growers and growers attribute blame to the DNSP rather than the third-party.

DNSPs typically provide a large amount of information at the beginning of the application process. However, the volume and complexity of information is likely overwhelming to growers. DNSPs have attempted to streamline the process by diverting applicants into different streams and categories based on the size and type of connections, however there remains a burdensome level of information to applicants.

There appear to be issues with information flow in both directions between DNSPs and growers. DNSPs reported that in all cases they communicate, in detail, issues that prevent application approval and furthermore provide suggested options that the grower might consider where their original connection application cannot be fulfilled.

However, growers report that they have received outright rejections for applications without explanations. One grower reported the DNSP requested the system be downsized on three separate occasions without an adequate explanation. In Queensland, many growers reported that they were not allowed to export at all as there was no capacity on the grid. This is contrary to the explanation of the process by Energy Queensland, that applications were not rejected but alternatives were suggested for network augmentation or export limitations. In NSW, growers complained they were receiving arbitrary, shifting export limitations. DNSPs also reported that they rarely deal directly with growers and do not appear to be aware of the issues growers report. This disconnect between the two stakeholders is a likely contributor to existing inefficacy of the process.

Communication to improve system design

Growers highlighted a lack of guidance or feedback on better placement, location or scale of the project – which can lead to several rounds of application without a guarantee of the success to the next step.

Lack of information on suitable locations for RE connections

There is limited information available for growers on the hosting capacity and export thresholds for local network when choosing whether to invest in RE. While information may be publicly available, growers are often unaware where to access the information. Further, there might be barriers in technical understanding of the information available. This leads to wasted time for both DNSPs and growers with applications in unsuitable locations or over-sized systems. It also represents a missed opportunity to collaborate in areas where non-network solutions may reduce network costs.

4.1.2.4 Contractual & Legal challenges

Lack of understanding of contracts

For small to medium scale systems, there is a need for growers to understand the contracts they sign with the DNSP. DNSPs often have standard contracts for small to medium scale systems. However, there is also an option to opt for negotiated contracts. The subtleties of the different contracts are not clear for growers.

While, this research does not critically examine the large scale solar developments, it came up in the case studies. The lack of local legal expertise in negotiating lease contracts with large solar developers is a big challenge faced by growers who want to adopt this business model. Since these are long terms leases (30 years), it is essential for growers to completely understand the contractual obligations and requirements. Particularly contentious are the end of life issues of rehabilitation and conservation of land, as there are few examples of such projects completing their life cycle.

Lack of dispute resolution mechanisms

Even when growers are unhappy with the process, they rarely approach formal dispute resolution mechanisms. Most are resolved through informal negotiations with the DNSP. In relation to suppliers, there are complaint processes established through the Solar Retailer Code of Conduct but there was no evidence of awareness of the code. Some growers have approached the state ombudsman's office to seek recourse from recalcitrant suppliers. However, the time and resources required to be engaged in a legal battle are often a deterrent for growers.

4.2 Grid connection of renewable energy: DNSP challenges & strategies

There are two key parties in the grid connection process for the on-farm RE – the DNSP to which the generator will be connected and the RE supplier, consultant or installer that manages the connection application on behalf of the grower. In practice, the DNSPs interviewed for this project both stated they rarely speak directly to growers and that the key interface is the third-party service providers who process the application.

From the DNSP perspective, connection application processes are generally relatively straight forward and clearly defined. DNSPs provide application documents that outline technical requirements for a connection application to be accepted, and generally applications are submitted by consultants on behalf of the farmers. The majority of consultants have prior experience with the DNSP and are therefore already familiar with technical requirements. Where applications do not address all requirements, or the specific connection request is deemed unsuitable for the network, DNSPs communicate the issue and provide alternative options for the site where suitable. Depending on the size of the proposed connection, modelling may be required to be

submitted as part of the application to demonstrate the generator is appropriate for the network.

The other challenge faced by DNSPs is grid visibility or ability of the DNSP to monitor network conditions. The logistics in monitoring and maintaining such an extensive network are a key constraint in the ability to plan and facilitate higher levels of renewable energy. The Network Opportunity Maps (NOM), developed by ISF in collaboration with DNSPs provide good visibility down to the zone substation level. The NOM shows:

- emerging needs for augmentation to meet rising demand (or 'constraints');
- the proposed value of the investment (and therefore the value available to a solution that uses distributed energy or demand management to ease the constraints); and
- the hosting capacity for renewable energy

However, as you move from the zone substation towards the fringe of the network, the ability to observe network conditions becomes increasingly difficult. Analysis of NOM in the four case study regions did not identify network constraints in the regions where growers have reported issues.

DNSPs noted that connection approvals are typically based on static modelling, that is, modelling that uses set historic or assumed values. This is because of the challenge in monitoring extensive sections of the network to produce data that would enable dynamic modelling capabilities. The distribution grid is the most dynamic element in our electricity infrastructure due to constantly changing loads and continuing DER penetration. Planning windows are therefore short and assessments are necessarily conservative to account for the constraint of low visibility and a lack of real-time data.

Whilst there is an intention to move to dynamic modelling for such assessments, the appropriate infrastructure to do so does not yet exist. A lack of visibility has therefore been identified as a barrier to renewable energy for growers as it potentially forces networks to limit the options available to a grower.

There is an inherent technical complexity to these issues but the key messages are:

- There are technical requirements that need to be satisfied to connect renewable energy to the grid;
- There is low levels of visibility or data on the condition of the network in many farming districts, which leads DNSPs to be conservative in managing connection applications;
- Communications and information flow between networks businesses and growers are not working well at present;
- Distributed energy, smart technologies that can address technical challenges, storage and demand management creates opportunities for growers and networks to work together to solve these issues and there are some promising results from pilot projects;
- There is uncertainty as to whether DNSPs can invest in improved data monitoring and network augmentation to integrate RE under RIT-D;
- Newly established schemes, the Demand Management Incentive Scheme and Demand Management Innovation Allowance, have provided up to \$1 billion in funding over 5 years for DNSPs to undertake projects that can save money by using these new technologies.

Table 4: Key Takeaways on Network Challenges

Challenge	Key Takeaways	Actions
DNSP Context	<p>DNSPs operate in a highly specific context with very particular needs and responsibilities. This fact does not undermine the principle that DNSPs are obligated to deliver effective services to consumers, however, it does highlight the need for a DNSP engagement strategy that allows for this contextual constraint to be managed in a way that benefits both DNSPs and growers.</p>	n/a
Complexity	<p>Connecting to electrical infrastructure is inherently complex. Applications are consequently burdened with highly specific technical and administrative requirements, a fact that is unlikely to change, at least in the near future.</p> <p>Whilst growers are typically more technically proficient than average electricity consumers, they are not necessarily in a position to spend a great deal of time on understanding the connection process, and they often deal in the more complex application types for larger connections. This is a key challenge for the DNSP in keeping the process efficient and effective: how much complexity should growers be exposed to?</p>	<p>Networks need to determine the level at which growers can practically engage with the complexity of the connection process and design their processes accordingly. This should include consideration of the grower/consultant relationship</p>
Potential Benefits of distributed energy resources	<p>It is generally accepted that DERs will likely deliver network benefits in the future, however the pathway to that future is yet unclear. DNSPs are still in the process of experimenting with and assessing DER based network solutions. Whilst the benefits of these solutions will encourage DNSPs to incentivise consumers to invest in DERs in the future, the infrastructure does not yet exist to support their use as grid assets.</p>	<p>Given that DNSPs are risk averse but also engaged in innovation, a productive approach is to target solutions that satisfy both those criteria. That is, solutions that progress DNSPs toward their vision of a transformed network in a low risk way. If growers can present off the rack solutions that entice the network, they are more likely to engage.</p>

Challenge	Key Takeaways	Actions
Equity	There is limited hosting capacity on the grid, and that which is available is allocated to those who are first to apply and succeed in network connection. The challenge here is best framed as: how can hosting capacity be increased to allow connection access to all growers?	Improve hosting capacity of the network through DER innovation such that access to connection opportunities is available to all electricity consumers
Data	Whilst data is readily available describing the distribution network at higher levels, details of feeder level network assets and below is difficult to obtain. Data at these lower levels, particularly at fringe-of-grid locations, is useful in identifying opportunities where DRE hosting capacity is adequate, or where it may even be beneficial, coupled with appropriate strategies. DNSPs are not naturally orientated towards disseminating such data due to operational constraints and data sensitivity.	<p>DNSPs need to move to more efficient and more effective forms of grid monitoring. This may include utilising customer owned/behind-the-meter assets like smart inverters, smart meters, etc.</p> <p>DNSP databases need to become better integrated to facilitate better data availability for opportunities identification</p>
Information	<p>DNSPs typically provide a large amount of information at the beginning of the application process. However, the volume and complexity of information is likely overwhelming to growers. DNSPs have attempted to streamline the process by diverting applicants into different streams and categories, however there remains a burdensome level of information to applicants.</p> <p>There appear to be issues with information flow in both directions between DNSPs and growers. DNSPs reported that in all cases they communicate, in detail, issues that prevent application approval and furthermore they provide suggested options that the grower might consider where their original connection application cannot be fulfilled. However, growers report that they have received outright rejections for applications without explanation. DPSPs also reported that they rarely deal directly with growers and do not appear to be aware of the issues growers report. This disconnect between the two stakeholders is a likely contributor to existing inefficiencies of the process.</p>	<p>Communicate to growers technical issues that constrain DRE opportunities like hosting capacity so they understand that getting in early may be beneficial</p> <p>If growers understand issues like hosting capacity and how they may be a grid asset, rather than liability, and the networks communicate with them about such things, there are more likely to be a host of solutions for greater access to DRE in the future</p>

Challenge	Key Takeaways	Actions
<p>Investment Uncertainty</p>	<p>Can networks invest in projects to improve visibility of low-voltage network conditions and network and/or non-network solutions to facilitate higher penetrations of DRE? In theory, the RIT-D framework might support network investment but in practice there is uncertainty.</p> <p>In the interviews we conducted with DNSPs, staff considered there was no scope for network augmentation where there were technical impacts; proponents were responsible for making capital contributions which could be recouped from subsequent connections. Placing the onus on individual proponents is neither equitable nor going to lead to an efficient level of investment. The Cutler Merz review (2018: 27) of NSW distribution networks noted similarly:</p> <p><i>The ability of distribution networks to invest in infrastructure to facilitate alternative energy system connections is even less clear. In many distribution networks across the NEM, the penetration of distributed generation is reaching levels sufficient to create unacceptable voltage rise and power quality impacts requiring investment in network reinforcement to first address existing issues and then to allow for increased penetration.</i></p> <p>The Australian Energy Market Commission has concluded the existing framework could support efficient investments to improve understanding of low-voltage networks but notes.</p> <p><i>'To date, there have not been any RIT-Ds that have considered this type of investment so there are limited precedents for distribution NSPs to understand how they would be assessed under the RIT-D. The Commission considers that establishing methodologies for valuing DER across a range of situations in which DER provides value to the network and wider market would have a number of benefits.'</i>¹⁵</p> <p>Our research supports this conclusion as it is not clear there is an understanding of how or under what circumstances networks can invest in better low-voltage network visibility and augmentations for integrate DRE.¹⁶ Indeed, network augmentation does not even appear to be considered as a possibility.</p>	<p>As the AEMC has recommended, the AER should provide guidance and worked examples to provide investment clarity for DNSPs are data monitoring and augmentation in low-voltage areas to integrate RE. The DMIS should provide an opportunity for the AER to trial and determine rules for the valuation of distributed energy resources and investment by networks.</p>

¹⁵ Further, the AEMC (2018: 102-03) noted: 'To date, there have not been any RIT-Ds that have considered this type of investment so there are limited precedents for distribution NSPs to understand how they would be assessed under the RIT-D. As part of a RIT-D process, the distribution NSP will also need to consider the methodology for valuing the market benefits of DER. We consider that there would be benefit in the AER providing increased guidance on the methodologies for valuing market benefits

Challenge	Key Takeaways	Actions
<p>Third party roles (Consultants)</p>	<p>Consultants have been identified as key influencers in determining how successful a grower may be in their application. DNSPs report that consultants typically become familiar with application processes, and are typically helpful to the process. However, they did also report cases where consultants had hindered the process by failing to meet basic requirements.</p> <p>Interviews with DNSPs suggest that the issues with information flow described may, in some cases, be directly attributable to consultants who deal with applications on behalf of the grower. The cause of this issue is not necessarily clear, however growers have suggested uncertainty in their ability to choose a trustworthy consultant, which may indicate that there is diversity in the quality of service available, and a need to support growers decisions.</p>	<p>Accreditation with the CEC may be a useful way for growers to differentiate between good and bad consultants. It may also be useful to produce a guide of what to look for, or what questions to ask, to determine if a consultant is good. It may suit growers to ask for references from previous clients as they may feel they can trust fellow growers.</p> <p>DNSPs need to ensure that applications received are complete and are authorised or submitted with the consent of the grower. An electronic 'gate system' requiring all fields to be completed and accepting electronic signatures could be an option.</p>

and including worked examples for distribution NSPs as part of its review of the application guidelines. Worked examples demonstrating a market benefit would be useful in relation to both to building monitoring capabilities if the AER considers this to be a RIT project and an augmentation of the distribution network to increase the hosting capacity for DER.'

¹⁶ The AEMC recommended this be done in the current review of the RIT-D guidelines. However, the draft RIT-D guidelines released in July 2018 do not specifically address issues related to distributed energy resources (AER 2018).

5 Recommendations

Grid connection processes are complex. There are Federal and State regulations, voluntary codes and each DNSP has significant discretion to develop and change its own processes and rules. It is not surprising that customers seeking to connect renewable energy systems find it difficult to navigate.

The reviews of Chapter 5A in operation have concluded grid connection processes have been inhibiting the uptake of renewable energy, identifying issues such as ambiguous and variable information requirements, connection fees, technical standards and service standards. Energy Networks Australia is currently developing voluntary model connection guides to address many of the issues identified in these reviews. The Australian Energy Market Commission has also recommended a review of the technical standards in network connection guides.

Our study does not aim to create a model grid connection process or framework, which is the focus of the ENA process, but instead aims to complement this work by:

- Examining the experience of growers in the process of installing and connecting renewable energy to validate and test the findings of these reviews in irrigation districts;
- Identifying opportunities to improve the understanding and communication with growers on the installation and connection of renewable energy;
- Identifying opportunities for collaboration between growers and networks to address barriers, notably through new funding vehicles such as the Demand Management Incentive Scheme and using the Network Opportunity Maps.
- Identifying opportunities for other energy stakeholders and governments to facilitate the uptake of on-farm renewable energy.

Some of the key themes to emerge from the research are summarised below before outlining recommendations.

5.1 Key themes

The experience of growers aligns with the conclusions of a series of reviews into grid connection for renewable energy following the establishment of Chapter 5a in the National Electricity Rules which have concluded the complexity, time and uncertainty of grid connection creates a substantial barrier for distributed renewable energy.

There is a need to make independent advice and support on energy technologies and processes available to growers – and solutions need to encompass vendors as well as the connection process

The issues growers experience with grid connection are strongly intertwined with other barriers to the uptake of renewable energy: grid connections are managed by third-parties (the supplier, installer or consultant) for growers and our research found high levels of distrust, reports of mal-practice and dissatisfaction with their performance from pre-sale through the connection process to post-sale. The lack of independent information or support for growers to select the right system and suitably qualified supplier - who will also generally manage the grid connection process – and confusion and mistrust growers felt towards suppliers, was a very strong theme throughout the research.

Solutions need to therefore encompass suppliers as well as the DNSPs and growers. Our research found little awareness or use of the Solar Retailer Code of Conduct by growers.

Communication processes and information transfers between DNSPs and growers are not working effectively

Another barrier for growers was the lack of clarity and understanding on the processes to connect to the grid. Our research found very little direct contact between the DNSPs and growers; grid connections are managed by a range of third-parties for growers (either the solar supplier, an installer or consultant). The third-party that mediates the relationship between the growers and DNSPs is usually selected when growers are purchasing systems. The transfer of information from DNSPs to growers via third-parties is not currently leading to effective communication and understanding.

All the distribution businesses are currently developing model connection processes through their peak body, Energy Networks Australia, to improve communications and information provision. To be effective, action will also be required to improve the communication through third-parties to growers.

There are many initiatives underway to develop model processes and trial innovative ideas. Not many are geared specifically to growers and their unique circumstances. Thus there is a need for growers to engage with DNSPs to collaboratively develop processes and projects that are mutually beneficial.

Network investment is required to improve visibility of conditions in low-voltage networks and improve information provision to applicants

As you move from the zone substation towards the fringe of the network, the ability to observe network conditions becomes increasingly difficult. Grid data is time sensitive. Several different systems are responsible for measuring and collecting data at different points on the network. Due to these challenges, connection approvals are typically based on static modelling, using set historic or assumed values. Planning windows are therefore short and assessments are necessarily conservative to account for the constraint of low visibility and a lack of real-time data.

Whilst there is an intention to move to dynamic modelling for such assessments, the appropriate infrastructure to do so does not yet exist. This potentially forces networks to limit the options available to a grower.

There is a need for demonstration projects to develop solutions to the technical constraints to increasing RE in low-voltage areas of electricity networks

There are procedural barriers (e.g. consistent, transparent information provision) but the main barrier to grid integration of renewable energy are the technical standards that need to be managed by networks to maintain security and reliability (primarily voltage and thermal limits which can be challenged by intermittent renewable energy).

It is important to note there is effectively no process for network-initiated projects for distributed energy resources (DERs) that could be identified at this stage. It is generally accepted that DERs will likely deliver network benefits in the future, but the pathway to that future is yet unclear.

Further clarity is required on the circumstances under which networks can invest in projects to improve data visibility of conditions in low-voltage networks and demonstrate distributed energy resources solutions. Demonstration projects are needed to trial the integration of innovative approaches and for the DNSPs to develop new processes that can adopt non-network solutions. Emerging technologies and pilot projects offer promising opportunities for DNSPs and growers to collaborate on solutions.

5.2 Recommendations

Recommendation 1: Establish Regional Energy Hubs to support growers and facilitate partnerships with DNSPs and other stakeholders.

Our study has highlighted a need to change the process by which growers are currently procuring and connecting RE. Our key recommendation is for the establishment of independent intermediaries that can provide independent information and advice to growers and facilitate interactions and partnerships between growers, installers and network service providers. A Regional Energy Hub with qualified, independent staff would enable growers to access the skills, information and expertise to develop and deliver RE projects (Coalition for Community Energy, 2016).

This study revealed that growers face a number of barriers to implement RE projects. In addition to connection issues, growers have limited time for research, limited information on suppliers and technologies and there is a lack of trust amongst growers in relation local installers and network providers – which is hampering the uptake of RE in the last five years. Hence, the establishment of an intermediary such as a Regional Community Energy Hub specifically tailored to the needs and requirements of growers could address those issues.

The effectiveness of an intermediary organisation has been proven nationally and internationally. The first Hubs have been implemented in Victoria through the pilot Community Power Hub Program. Three Hubs have been established in Ballarat, Bendigo and in the Latrobe Valley (hosted by local not-for profit organisations with their own governance structure).

The funding for a Regional Energy Hub could be provided through state government programs. The NSW has recently announced a Regional Community Energy program which includes grants for up to five community energy hubs. Grower organisations should collaborate to develop a proposal for one of these hubs to be a 'Growers Energy Hub'.

The 'Growers Energy Hub' could provide independent information on technologies, consumer rights, solar suppliers, grid connection processes, coordinate outreach education programs and develop partnerships with councils, funders, technology providers and networks to deliver innovative RE projects such as bulk-buy initiatives and demonstration projects.

Figure 12 sketches out how the 'Growers Energy Hub' could work and change the current process for installing and connecting RE - taking on the role of a trusted broker for growers but also support the growth of network-initiated projects that deliver win-win outcomes.

Grower Initiated

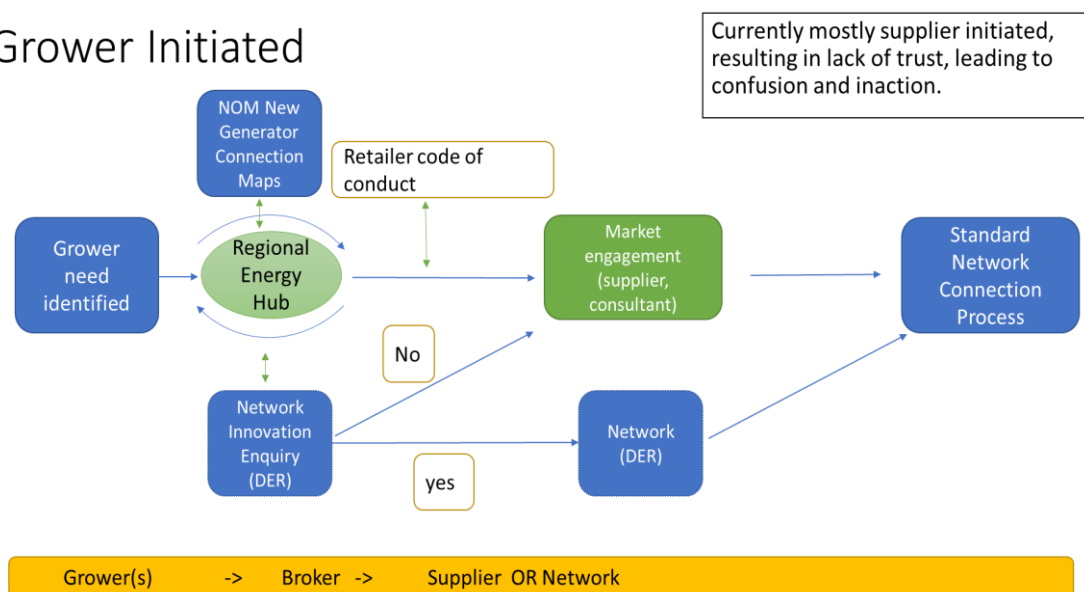

Figure 12: Grower-Initiated Projects with a Regional Energy Hub

The Hub can identify and aggregate projects / applications from different sources:

- Growers can directly approach them;
- DNSPs can raise a Network Innovation Enquiry for DER
- Through the Network Opportunity Maps (NOM)

The hub could also support DNSPs improve their efficiencies through filtering the rapidly growing number of connection applications by raising awareness of necessary network information such as the New Generator Connection Maps and the solar retailer code of conduct. As networks develop processes to identify DER projects, the hubs could recruit growers into these projects by referral to the network business. This could lead to demonstration project, BAU connection application, or concept termination.

Recommendation 2: Changes to National Electricity Rules, Chapter 5A (Electricity connection for retail customers) should be considered if voluntary model grid connection processes fail to meet performance benchmarks.

Energy Networks Australia, the Clean Energy Council, energy regulatory bodies and Energy Consumers Australia are developing voluntary model connection processes (micro, low, medium and high-voltage) that will be implemented by each of the DNSPs.

Many of the issues identified in this study and other reviews of Chapter 5A of the National Electricity Rules can be addressed by the DNSPs without rule changes and through voluntary codes. These issues include creating a common communications platform, standardised and streamlined technical requirements, better information provision for applicants and industry.

However, it has also been noted by several reviews that the network connection process is currently lightly regulated without oversight as to whether network rules strike the appropriate balance between consumer interests and grid stability.

If the voluntary model process does not deliver results, regulatory approaches should be implemented including creating a clear process for oversight of network connection process rule-setting. The Australian Energy Regulator should establish clear and

specific performance benchmarks for evaluating the voluntary codes based on issues and criteria identified in past reviews and the energy rule determination in 2014:

- Provision of transparent information requirements;
- Fair and reasonable connection costs;
- Connection process times;
- Entry to market for new technologies;
- Service standards.

Further, independent evaluation of the voluntary codes is scheduled to occur within 2-years but it is unclear whether that evaluation will include consultation with actual customers such as growers. Our research has highlighted the lack of communication between the end-users and DNSPs. It is important the 'customers' for the connection process (end-users and the specialists who manage connections for them) are involved as part of the evaluation process.

Recommendation 3: DNSPs and Grower Cooperatives/Industry Associations should investigate opportunities for demonstration projects through the Demand Management Incentive Scheme and Demand Management Innovation Allowance.

One of the main barrier to grid integration of RE are the technical standards that need to be managed by the DNSPs to maintain security and reliability, primarily voltage and thermal limits which can be challenged by intermittent RE. Equally, DNSPs need to develop processes that can enable them to take advantage of the opportunities presented by DER.

Pilot projects are highlighting real solutions that could unlock the capacity for growers to install higher volumes of RE. For example:

- *Networks Renewed*: Stage 1 of an ARENA-funded project with DNSPs has successfully demonstrated that smart inverters can be used with solar PV to manage voltage issues. A larger-scale demonstration project could test their use across different sectors and network contexts.
- *REALM (Renewable Energy and Load Management)*: Stage 1 of an ARENA-funded project with seven major businesses has identified the scope to use existing on-site storage and load flexibility to increase the value of RE and match supply and demand, generally at a lower cost than new batteries. REALM Stage 2 is currently being developed to implement two pilots involving DNSPs and retailers to test different types of load flexibility opportunities with tariffs that align prices with the value that can be created for DNSPs and energy markets. Irrigation projects would also offer excellent opportunities to apply REALM, especially crops where there is flexibility in timing of pumping, on-site refrigeration, cooling and heating or material storage.
- *Microgrids*: There are several microgrid trials across the country. These trials are highlighting how RE can benefit both the DNSP and consumers. Used smartly, these approaches can help in mitigating expensive network augmentation and replacement costs and enhance reliability. Both Energy Queensland and Essential Energy are considering options for microgrid projects.
- *Local Electricity Trading*: There are a few trials on peer to peer energy trading in Australia. For example, LO3 and ARENA are using Blockchain technology to allow households and businesses to trade or share locally generated power with each other in Latrobe Valley, Victoria. Power Ledger is working with Origin to explore the benefits of this mechanism.

Funding for these types of projects is potentially available through the Demand Management Incentive Scheme, Demand Management Innovation Allowance, the Regulatory Investment Test – Distribution (RIT-D) and ARENA. Grower associations and cooperatives should investigate opportunities for the deployment of projects in partnership with the DNSPs, and potentially with ARENA and state governments.

Once the DNSP has identified potential areas, Regional Energy Hubs could play an ongoing role brokering partnerships for network-initiated projects and supporting networks to develop a new, pro-active role in harnessing distributed energy. A process for how network-initiated projects with the involvement of regional energy hubs might work is presented in Figure 13.

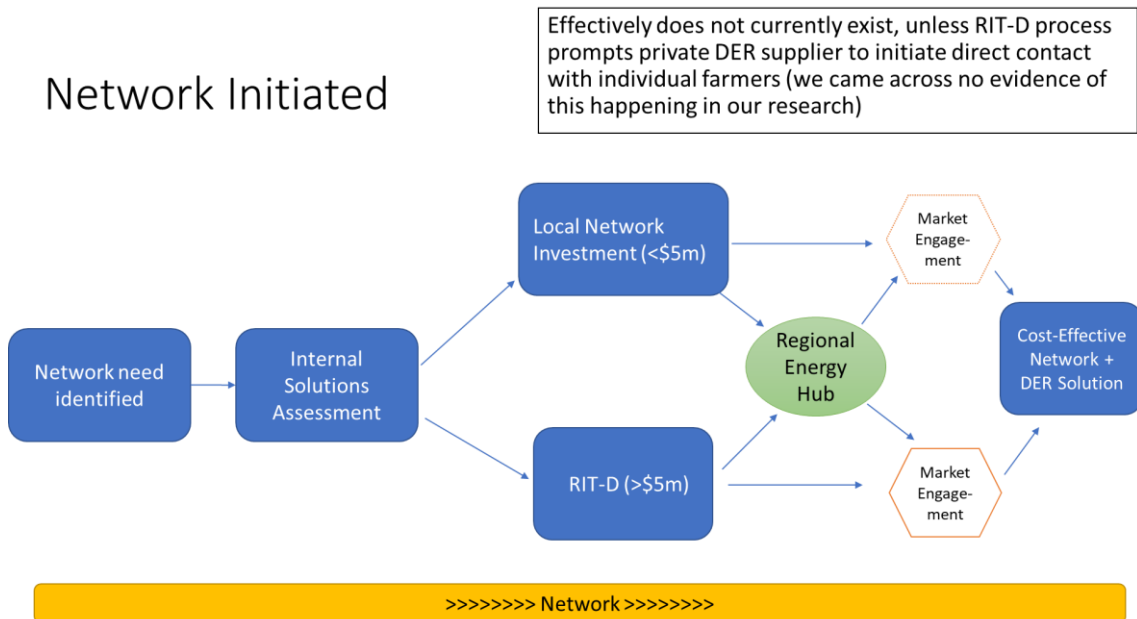

Figure 13: Network Initiated Distributed Energy Projects

DNSP needs identification and investment decision making currently exists in a completely different world from growers. There is a need for a nimbler process for smaller, local investments (<\$5m) via NOM (Network Opportunity Maps) and Demand Side Engagement Register (outside the longer RIT-D process). This ensures there is a collaborative pathway to the 'cost effective network DER solution'. However, this also necessitates better visibility on the network to pre-empt problems and proactively seek out projects in vulnerable areas. This ties in with Recommendation 6.

Once the DNSP has identified potential areas, they connect with the regional energy hubs to reach out to customers in a targeted manner. A regional energy hub as a trusted broker directly engages with both small and large market engagement processes, and the DNSP can interact directly with brokers to see if any non-network solutions exist amongst growers. The broker engages with growers to activate any projects within a given region that might be in development or 'on ice'. From the DNSPs side, their innovation arms like Yurika in Queensland (Energy Queensland) and Mondo power in Victoria (AusNet Services) can take the lead in conceptualising network-initiated DER projects.

Recommendation 4: The AER should provide clear guidance to DNSPs on network expenditure on low-voltage network data and procedures to facilitate cost effective distributed energy and demand management.

Investment is required to address the two major technical barriers to integrating higher penetrations of RE:

- Improved information and data on network conditions in low-voltage feeders: networks will continue to apply conservative export limits without better information to determine the actual times and locations when constraints occur.
- Network augmentation (e.g. voltage regulators) and/or non-network solutions (e.g. smart inverters with on-site PV) to maintain technical standards (e.g. voltage regulation and thermal limits) whilst integrating distributed renewable energy.

Higher levels of distributed renewable energy can reduce the energy bills of growers but also, if managed well, potentially deliver system-wide reductions in the cost of generation and networks.

In theory, the RIT-D framework might support network investment to improve visibility of low-voltage network conditions and network and/or non-network solutions to facilitate higher penetrations of DER but in practice there is uncertainty over eligibility and requirements for funding.

In the interviews we conducted with DNSPs, staff considered there was no scope for network augmentation where there were technical impacts. In such cases, proponents were responsible for making capital contributions which could be recouped from subsequent connections. Placing the onus on individual proponents is neither equitable nor likely to lead to an efficient level of investment. The Cutler Merz review (2018: 27) of NSW distribution networks noted similarly:

The ability of distribution networks to invest in infrastructure to facilitate alternative energy system connections is even less clear. In many distribution networks across the NEM, the penetration of distributed generation is reaching levels sufficient to create unacceptable voltage rise and power quality impacts requiring investment in network reinforcement to first address existing issues and then to allow for increased penetration.

The AEMC has looked at the question of whether networks can invest in improved low voltage network data, modelling and monitoring. In its 2017 *Distribution Market Model Review* (p.45), they concluded it was 'unclear' - although in the 2018 *Economy Regulatory Framework Review* the AEMC assessed that the existing framework could support efficient investments to improve understanding of low-voltage networks.

The AEMC has also noted there is an absence of precedents for distributed energy resources in RIT-D and recommended the AER provide clarity and worked examples to support investment.

*'To date, there have not been any RIT-Ds that have considered this type of investment so there are limited precedents for distribution NSPs to understand how they would be assessed under the RIT-D ... The Commission considers that establishing methodologies for valuing DER across a range of situations in which DER provides value to the network and wider market would have a number of benefits.'*¹⁷

¹⁷ Further, the AEMC (2018: 102-03) noted: 'To date, there have not been any RIT-Ds that have considered this type of investment so there are limited precedents for distribution NSPs to understand how they would be assessed under the RIT-D. As part of a RIT-D process, the distribution NSP will also need

Our research supports this conclusion as it is not clear there is an understanding of how or under what circumstances networks can invest in better low-voltage network data visibility and augmentations to integrate DER¹⁸. Indeed, network augmentation does not even appear to be considered as a possibility. The DMIS should provide an opportunity for the AER to trial and determine rules for the valuation of distributed energy resources and investment by networks.

Recommendation 5: DNSPs should improve the provision of information to growers on locational opportunities and constraints for the connection of RE.

Greater provision of information on system stability and reliability could allow identification of other value streams not yet monetised and driving network capital expenditure and guide connection applications (saving both networks and growers time and resources). Growers have limited insight into the capacity of the local network to accommodate RE and opportunities to reduce network costs.

There are a number of ways in which information could be improved

- *Increase availability of data on system reliability and/or stability* to increase market and end user insight into areas of network need that might represent DER value provision to the DNSPs local customers, but may not yet be reflected in the DNSP investment plans. This could be done through existing public data platforms such as the Network Opportunity Maps (NOM), or via direct communication with specific parties looking to coordinate opportunities. A regional energy hub could link closely with strategic regional economic planning.
- *Continue to improve disclosure and granularity of new generator network connection capacity* data to direct early stage distributed energy project investigations. For NSW this involves exploring the provision of data below 33kV, and for Queensland, a first step is the provision of data for 33kV and above, to connect with the information supplied by the transmission network, Powerlink.
- Ensure all potential future network constraint investments and sub-investments are disclosed as part of System Limitation Reports (then mapped to the NOM), including those with varying degrees of uncertainty. This includes smaller investments in the low-voltage system that might not traditionally be exposed to a regulatory investment test (RIT-D) process.

Recommendation 6: State Governments should engage with the third-parties that manage grid connection processes and works to improve third party communication with growers.

All third party suppliers, need to be registered with State Governments. In NSW, ASPs are required to be accredited and registered by the Department of Planning and Environment. In both states, an electrical licence holder is required for installations. In

to consider the methodology for valuing the market benefits of DER. We consider that there would be benefit in the AER providing increased guidance on the methodologies for valuing market benefits and including worked examples for distribution NSPs as part of its review of the application guidelines. Worked examples demonstrating a market benefit would be useful in relation to both to building monitoring capabilities if the AER considers this to be a RIT project and an augmentation of the distribution network to increase the hosting capacity for DER.'

¹⁸ The AEMC recommended this be done in the current review of the RIT-D guidelines. However, the draft RIT-D guidelines released in July 2018 do not specifically address issues related to distributed energy resources (AER 2018).

Queensland, it is advised that the installer has a Clean Energy Council accreditation and a relevant Queensland Building and Construction Commission (QBCC) licence or an unrestricted electrical contractor licence.

State governments should use their position and experience to influence third-parties in relation to service standards and communication with end-users. The State Governments should ensure that the accreditation and registration process also includes a check-list or guideline for third parties on the service expectations for growers and other consumers. The accreditation process aims to facilitate the market, but compliance and enforcement should be considered in its establishment.

All the distribution businesses are currently developing model connection processes through their peak body, Energy Networks Australia, to improve communications and information provision. To be effective, action will also be required to improve the communication through third-parties to growers and guidelines for service providers would assist in this process. However, this is an issue state governments should monitor as part of their accreditation role and use periodic audits to ensure third parties are following guidelines.

Recommendation 7: DNSPs should establish an on-line register with information on past connection applications for RE and a FAQ for third-parties to distribute to applicants.

One of the ways in which DNSPs could help growers to understand connection process is to establish an on-line register which summarises the results of past connection applications by region. Key information provided would include the size of the application, the result of the application and reasons where there were alterations or refusal.

The benefits would include:

- Signalling for the market where there are hosting capacity constraints and in general recent outcomes of connection applications to shape expectations;
- Better understanding for future applicants of the connection process to prevent mistakes, incomplete or unacceptable applications;
- Improved capacity for DNSPs and the market to analyse trends and identify issues that require resolution for future applicants. In addition to informing applicants, aggregation of data will improve visibility of issues for DNSPs.

The U.S. Department of Defense (DoD) clearinghouse for siting renewable energy technologies is a central location to provide information and act as a resource to assist interested individuals and organisations understand the mission impacts of proposed energy projects near military activities, and the Department's MCE process, procedures, and mitigation opportunities.

This could take the form of a relevant page on the website or an additional layer on the Network Opportunity Maps (which already includes information from DNSPs).

A key issue that would need to be addressed is privacy concerns of previous applicants. The DNSP would need to develop a process to obtain customer consent prior to sharing information publicly or widely.

Alongside the establishment of a register, DNSPs can develop a factsheet or FAQs that explains responses to commonly received problems in accessible language. For DNSPs, the 'customer' is usually the third-party that manages the connection process or works, rather than the end user, but poor communication with growers is harming the DNSP's reputation and sowing confusion. DNSPs could assist in improving

communication by developing a FAQ to be distributed by third-parties to growers (and other connection applicants).

State Governments could support the DNSP initiative by bringing together the different DNSPs in their jurisdiction to support its development. State wide programs will help build a broader community of practice and experience sharing.

Transmission networks are required to publish information on new connections under the draft Transmission Annual Report Guidelines (section 4.1.3). Our recommendation is that DNSPs should also be required to publish basic information on past connection applications to assist non-expert applicants such as growers and the parties that manage their connection applications.

Recommendation 8: The Clean Energy Council and Energy Consumers Australia should undertake outreach engagement to improve the effectiveness of the Solar Retailer Code of Conduct.

The Solar Retailer Code of Conduct, a voluntary code administered by the Clean Energy Council to promote best practice by the vendors of solar systems, was launched in 2013 (Clean Energy Council, 2017b). The code is reviewed and authorised by the ACCC and overseen by an independent Code Review Panel. The Panel is established in accordance to the Code of Conduct and in line with ACCC requirements to have an independent chair and representatives who are not signatories to the Code. The Code Review Panel meets four times a year with the aim of ensuring the code is operating effectively. The coverage of the Solar Retailer Code of Conduct is growing strongly; the 2017 annual report stated there were 54 signatories accounting for 15 per cent of sales but the latest code statistics report there are almost 100 suppliers registered (Clean Energy Council, 2018).

The Solar Retailer Code of Conduct contains a range of checks and protections for consumers. The CEC does not admit any vendors until there is at least 12 months of operation and runs checks on the personnel for past corporate history such as bankruptcy (the 2017 annual report states around half of applications had been rejected). Approved retailers must offer a 5-year warranty on parts, use accredited designers and installers, and comply with information requirements. The code includes a detailed complaints process for investigating, managing and reporting on complaints and code breaches (Clean Energy Council, 2017a).

The Solar Retailer Code of Conduct is potentially a vehicle for improving standards amongst solar vendors for Growers. However, the code will be effective only if used by consumers to select accredited suppliers and if consumers use enforcement mechanisms for non-compliant signatories. Voluntary codes work where suppliers see them as essential for business and there is a credible risk of consequences for non-compliance (e.g. reputation damage). Our research found no awareness of the code and major dissatisfaction with solar suppliers amongst growers.

The CEC is currently updating the code and increasing resources for audit and compliance. The code will be released for public input. It is recommended the CEC and ECA engage with agricultural industry bodies to increase the awareness and effectiveness of the Solar Retailer Code of Conduct in regional areas.

Recommendation 9: State Governments should establish mandatory minimum retailer feed-in tariffs for solar.

The financial viability of renewable energy installations can be impacted by the grid connection to export to earn feed-in tariffs during off-peak periods. However, retailer

feed-in tariffs for solar PV are in general low, highly variable, there are many different offers to evaluate and there is effectively no scope for negotiation.

In NSW, IPART sets a voluntary benchmark based on its assessment of the economic value of the output (currently 6.9 – 8.4c/kilowatt-hour). However, the 2018 review shows only a handful of retailer offers were within the recommended benchmark (shaded grey area) for the previous year.

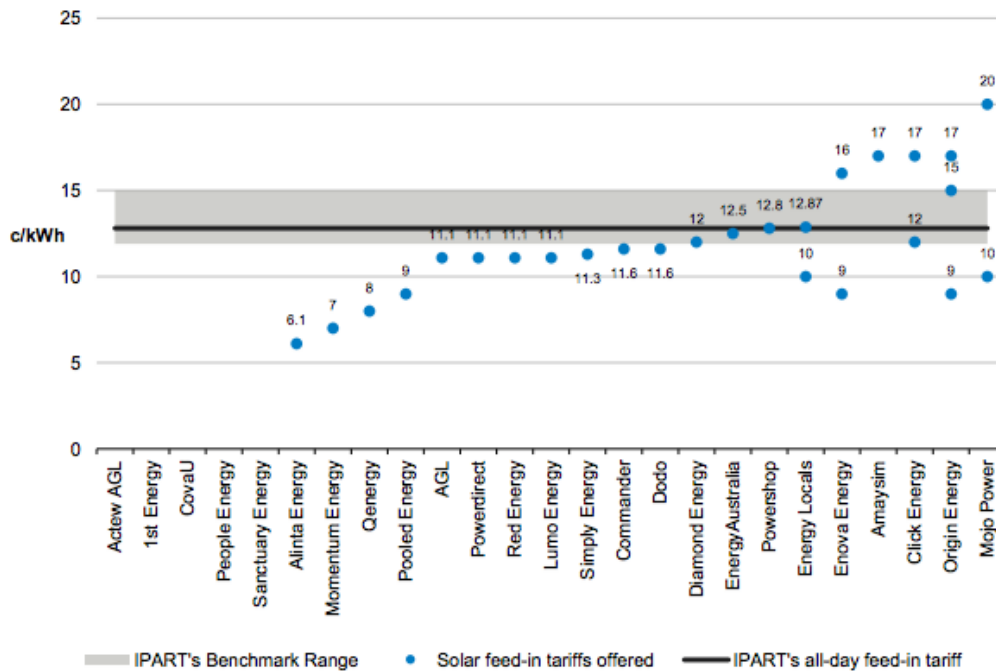

Note: Enova Energy was only retailing in the Essential Energy network area and Pooled Electricity was only supplying electricity in the Ausgrid and Endeavour Energy network areas.

Data source: IPART analysis, using data from www.energymadeeasy.com.au.

Figure 14: Solar Feed in Tariffs in NSW, based on retailers' market offers in April 2018

Additionally, in the next figure, IPART analysis demonstrates there is no correlation between the lowest bills and solar feed-in tariff as the offers with the highest rates for exported electricity are not necessarily the best deals on other charges. This adds significant complexity to choosing retailers.

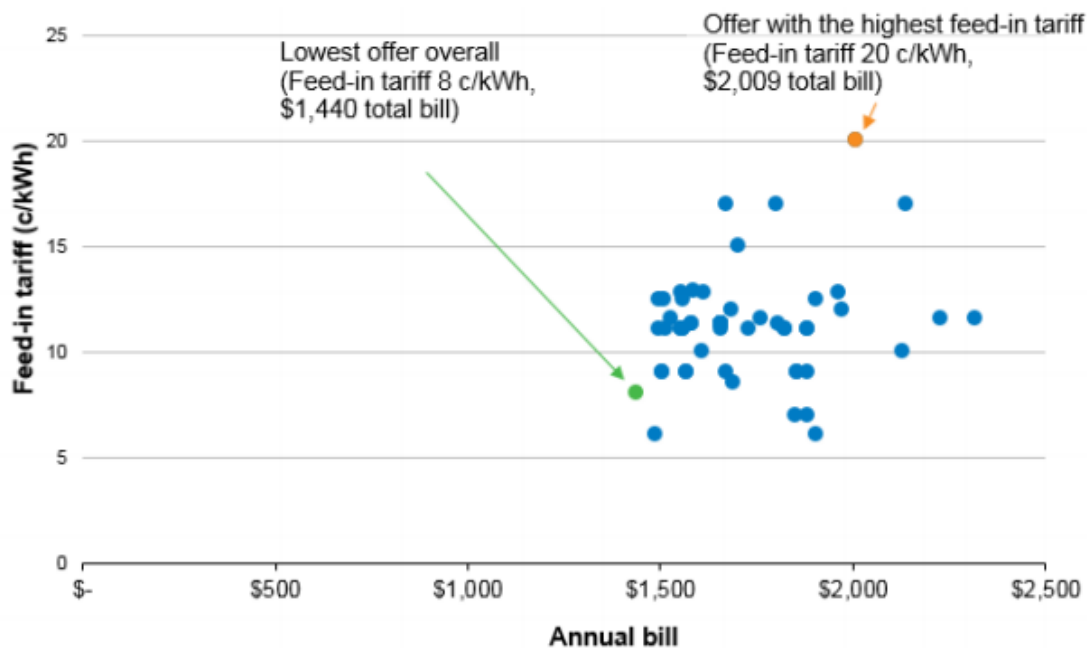

Note: in this example, the 2 kW solar system generates 2,546 kWh per year.

Data source: IPART

Figure 15: Annual bills & Feed in Tariffs (April 2018, Ausgrid network area)

In Victoria, the Essential Services Commission sets a minimum feed-in tariff for solar PV based on the economic value of the power (avoided wholesale purchases and network and retailer costs). The minimum rate is updated annually and now includes a time-varying tariff to reflect the change in value across the day between peak, shoulder and off-peak times (Essential Services Commission, 2018).

Table 5: Minimum Solar Feed-Tariffs for Victoria

Period	Weekday	Weekend	Tariff
Single-rate	n/a	n/a	9.9
Off-peak	10pm – 7am	10pm – 7am	7.1 c/kWh
Shoulder	7am – 3pm, 9pm – 10pm	7am – 10pm	10.3 c/kWh
Peak	3pm – 9pm		29.0 c/kWh

Note: the much higher rate for 3pm onwards creates an incentive for west-facing systems that produce much output later in the day which also assists with network integration.

If NSW or Queensland were to follow the lead of Victoria and set a mandatory minimum solar feed-in tariff based on the economic value of the exported electricity, this would reduce complexity, the transaction costs for growers and assist in creating a level-playing field and supporting the financial viability of on-farm RE.

Recommendation 10: Grower cooperatives and large users should be provided with support to investigate the feasibility of Renewable Energy Power Purchase Agreements (RE PPA).

Improving visibility in regional areas of the network and developing technical solutions will take time. Emerging options such as off-site RE power purchase agreements have the benefit that they are located in areas of the network that can manage power and the developer manages the relationship with the grid. Investigating the feasibility of RE power purchase agreements is a solution that should be developed for growers.

A Power Purchase Agreement is a way of purchasing RE (for sale or supply) from an independent power generator, where the purchaser or energy user makes a contract to buy a portion of their load for a set price from a solar or wind farm over a longer-term period (typically 7-10 years).

There are a number of potential benefits for growers from RE PPAs”

- A third-party manages the network connection process without any involvement from the grower;
- If they are located in an area with network constraints, the plant can be located in an area of the network that has the capacity to integrate the output;
- Reduced electricity costs and greater certainty on energy costs by fixing a portion of their consumption over a longer time period;
- Lower carbon footprint and improved brand image.

A growing number of organisations are signing power purchase agreements with RE generators. Major organisations such as Telstra, Australia Post, Coca Cola, and ANZ have signed RE PPAs in the past year. Large agricultural energy users or cooperatives acting on behalf of their members could negotiate RE PPAs.

RE PPA's are a relatively new development in Australia. Some retailers are offering access to RE PPA's they have negotiated with a solar or wind farm as part of their offering – a trend likely to grow - but for most growers they would need to negotiate directly or through a cooperative with a RE developer. There are a range of costs, benefits and risks that need to be understood and most are ill-equipped to negotiate a RE PPA.

Consequently, education and feasibility assessment are required for growers to decide if a RE PPA is the right option for them. Funds to enable grower cooperatives to undertake a feasibility study, member engagement and education on RE PPAs should be provided by state governments (such as the NSW Climate Change Fund or through the Queensland Renewable Energy Plan). Regional energy hubs would also be a natural platform for engagement (Prendergast *et al.*, 2018).

6 References

ACCC (2018) *Restoring electricity affordability and Australia's competitive advantage Retail Electricity Pricing Inquiry-Final Report*. Available at: www.accc.gov.au (Accessed: 10 September 2018).

Agriculture Industries Energy Taskforce (2017) *Agriculture Industries Energy Taskforce Response to COAG Energy Council Consumer participation in revenue determinations Supporting industry and jobs through accessible, reliable and affordable energy*. Available at: https://www.qff.org.au/wp-content/uploads/2017/04/Ag-Industry-Energy-Taskforce-SUB_COAG-Energy-Council_consultation-paper_Nov-2017-FINAL.pdf (Accessed: 30 May 2018).

Ausgrid (2018) *Determination 2019-24, Australian Energy Regulator*. Available at: <https://www.aer.gov.au/networks-pipelines/determinations-access-arrangements/ausgrid-determination-2019-24/proposal#step-57777> (Accessed: 4 October 2018).

Australian Energy Regulator (2017a) *Explanatory statement: Demand management incentive scheme*. Available at: https://www.aer.gov.au/system/files/AER_-_Explanatory_statement_-_Demand_management_incentive_scheme_-_14_December_2017.pdf (Accessed: 4 October 2018).

Australian Energy Regulator (2017b) *Explanatory statement Draft demand management innovation allowance mechanism*. Available at: https://www.aer.gov.au/system/files/AER_-_Explanatory_statement_-_Draft_demand_management_innovation_allowance_mechanism_-_28_August_2017.pdf (Accessed: 4 October 2018).

Bailey, M. (2017) 'LO3 to trial peer-to-peer energy sharing in South Australia', *Australian Financial Review*, 17 October. Available at: <https://www.afr.com/business/energy/lo3-energy-to-trial-peertopeer-energy-sharing-in-south-australia-20171010-gyxw3s>.

CBA (2018) *CommBank Agri Insights. Exploring energy use and investment in the Australian agribusiness sector CommBank Agri Insights Report*. Available at: <https://www.commbank.com.au/content/dam/commbank/assets/business/can/agribusiness/agri-insights-9.pdf> (Accessed: 2 September 2018).

Clean Energy Council (2017a) *Complaints Procedure - Solar Accreditation*.

Clean Energy Council (2017b) *Solar Retailer Code of Conduct Annual Report 2017*. Available at: <http://www.solaraccreditation.com.au/retailers/statistics.html>.

Clean Energy Council (2018) *Solar Accreditation - Reports and statistics, Clean Energy Council*. Available at: <http://www.solaraccreditation.com.au/retailers/statistics.html> (Accessed: 8 October 2018).

ClimateWorks Australia, Property Council of Australia and Seed Advisory (2015) *Implementing the Connecting Embedded Generation Rule Project Outcomes Report*. Available at: <http://www.seedadvisory.com.au/wp-content/uploads/2015/05/Implementing-the-Connecting-Embedded-Generation-Rule-Report-FINAL-2.pdf> (Accessed: 20 September 2018).

Climateworks Australia and Seed Advisory (2018) *Plug & Play 2 Enabling distributed generation through effective grid connection standards*. Available at: https://www.climateworks.com.au/sites/default/files/documents/publications/plugplay_2

_report.pdf.

ClimateWorks Australia and Seed Advisory (2017) *Plug & Play: Facilitating grid connection of low emissions technologies*. Available at: <https://climateworks.com.au/sites/default/files/documents/publications/plugplay.pdf> (Accessed: 20 September 2018).

Coalition for Community Energy (2016) *NSW Climate Change Fund-Draft Strategic Plan Coalition for Community Energy Submission*. Available at: <http://cpagency.org.au/wp-content/uploads/2016/12/C4CE-Submission-Climate-Change-Fund-Draft-Strategic-Plan-Dec-2016.pdf> (Accessed: 22 October 2018).

CSIRO & Energy Networks Australia (2017) *The Electricity Network Transformation Roadmap*. Available at: www.energynetworks.com.au/roadmap (Accessed: 3 September 2018).

CutlerMerz (2018) *Investigation into NSW regulation, processes, and standards for network connections of advanced energy systems*.

Dairy Australia (2017) *Ease the squeeze on dairy shed power costs*. Available at: https://webcache.googleusercontent.com/search?q=cache:VDwlu_OvYswJ:https://www.dairyaustralia.com.au/-/media/dairyaustralia/documents/farm/environment/energy-costs/ease-the-squeeze-on-dairy-shed-power-costs.ashx+&cd=3&hl=en&ct=clnk&gl=au.

Department of Planning & Environment, N. G. (2017) *Accredited Service Provider (ASP) Scheme and contestable works - NSW Energy, Department of Planning & Environment, NSW Government*. Available at: <https://www.energy.nsw.gov.au/energy-supply-industry/pipelines-electricity-gas-networks/network-connections/contestable-works> (Accessed: 3 September 2018).

ENA (2018) *Distributed Energy Resources Grid Connection Guidelines Framework and Principles*. Available at: www.cutlermerz.com (Accessed: 2 September 2018).

Energieia (2016) *EMBEDDED GENERATION GRID CONNECTION STANDARDS SCOPING STUDY*. Available at: <http://fpdi.cleanenergycouncil.org.au/reports/grid-connection-standards-scoping-study.html>.

Ergon Energy Network (2018) *Network Online Services Connect Application Guide*. Available at: https://www.ergon.com.au/__data/assets/pdf_file/0017/350009/Network-Online-Services-Connect-Application-Guide.pdf (Accessed: 8 October 2018).

Essential Energy (2015) *CEOP2513.06 Connection Policy - Connection Charges*. Available at: <https://www.essentialenergy.com.au/-/media/Project/EssentialEnergy/Website/Files/Our-Network/CEOP251306.pdf?la=en&hash=7215B5AFE3DF17CEE3E5E9010056E81EEC4CCFAF> (Accessed: 8 October 2018).

Essential Services Commission (2018) *2018—19 feed-in tariffs*. Available at: www.esc.vic.gov.au/about-us. (Accessed: 8 October 2018).

FCA (2016) *Australian Farmer Climate Survey*. Available at: https://d3n8a8pro7vhmx.cloudfront.net/farmersforclimateaction/pages/64/attachments/original/1480387204/FCA_survey_digital.pdf?1480387204 (Accessed: 28 August 2018).

Heath, R., Darragh, L. and Laurie, A. (2018) *The impacts of energy costs on the Australian agriculture sector - Reserach Report*. Available at: http://farminstitute.org.au/publications/research_report/energy.

Institute of Sustainable Futures (2018) *Networks Renewed | University of Technology*

Sydney, *University of Technology Sydney*. Available at: <https://www.uts.edu.au/research-and-teaching/our-research/institute-sustainable-futures/our-research/energy-and-climate-1> (Accessed: 4 October 2018).

Johnston, S. (2018) 'Connecting solar and batteries to the grid | Energy Networks Australia'. Energy Networks Australia. Available at: <https://www.energynetworks.com.au/news/energy-insider/connecting-solar-and-batteries-grid> (Accessed: 3 September 2018).

NSW Farmers' Association (2017) *Submission to ACCC's preliminary report on the Retail Electricity Pricing Inquiry*. Available at: [https://www.accc.gov.au/system/files/NSW Farmers .pdf](https://www.accc.gov.au/system/files/NSW%20Farmers.pdf) (Accessed: 10 September 2018).

NSW Farmers and GSES (2015) *Solar-powered pumping in agriculture: A guide to system selection and design, NSW Farmers*. Available at: <http://www.aginnovators.org.au/agiprojects/OEH-Solar-PV-Pumping-Guide/> (Accessed: 2 September 2018).

Prendergast, J. *et al.* (2018) *Best of Both Worlds: Renewable Energy and Load Flexibility for Australian Business Customers*. Available at: www.isf.uts.edu.au (Accessed: 19 August 2018).